

ring

Flood & Freeze Sensor
For Ring Alarm



Prevent water and ice damage at home.

Ring Flood & Freeze Sensor is a smart sensor for your Ring Alarm system. Place it anywhere you want to monitor for flooding or freezing conditions.

On the bottom of the Sensor, you'll see flood sensors that can tell when water is present. Inside, a temperature sensor keeps watch for dangerously low temperatures (around 40 ° F or 4.4 ° C).

When either of these conditions occur, the Ring app notifies you so you can take care of the issue.

Contents

1. Diagram
2. In-app Setup
3. Physical Installation
4. Additional Information

1. Say hello to your Ring Flood & Freeze Sensor.

Diagram

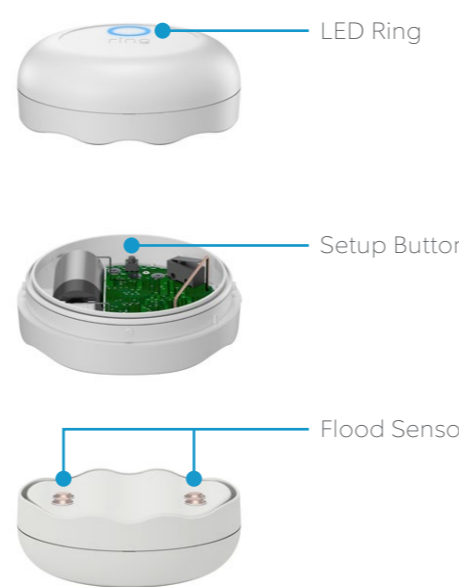

2. Set up your Ring Flood & Freeze Sensor in the Ring app.

Begin the setup process near your Ring Alarm Base Station.

To add devices to your Ring Alarm, it must be disarmed. If your Ring Alarm is armed, please disarm it now.

In the Ring app, tap **Set Up a Device** and find Ring Flood & Freeze Sensor in the **Security Devices** menu.

To complete the setup process, follow the in-app instructions.

When prompted, scan the QR Code or enter the PIN.

This begins the pairing process. The QR Code and PIN are on the back of your sensor and in the product packaging.

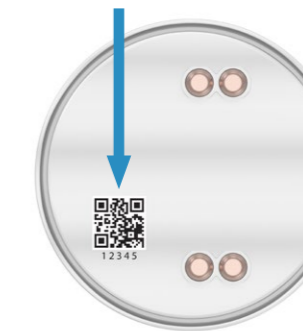

When prompted, open the lid and pull out the clear tab.

Twist the lid to the left to unlock, then lift it to remove. Next, pull out the clear battery tab. This turns on the Sensor.

Your Base Station finds it automatically.

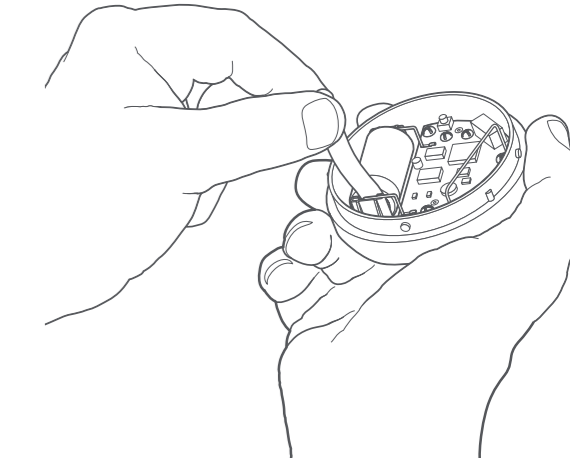

Can't scan the QR code?

No problem! In the app, on the scanning screen, tap **Not working? Enter number instead**.

Then, enter the 5-digit PIN code you'll see below the QR code. Next, you'll put your Sensor in manual pairing mode.

To do this, open the Sensor, then remove and reinstall the battery. Finally, press the Setup Button to begin pairing.

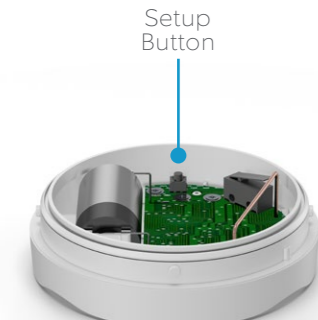

Watch your Sensor connect.

As your Sensor pairs to your Base Station, its LED ring blinks slowly, then quickly. Once the Sensor is paired, the LED glows blue for three seconds.

i If the Sensor does not pair successfully, the LED ring glows red. To try the pairing process again, remove and reinstall the battery inside the Sensor.

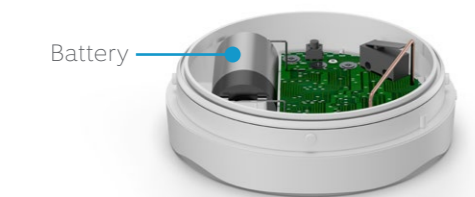

3. Place your Ring Flood & Freeze Sensor.

Test your Flood & Freeze Sensor.

Now that your Sensor is set up, bring it to the area you want to monitor. To ensure it remains connected to your Alarm Base Station in its new location, test the Sensor.

To do this, push the Setup button inside the Sensor. If the LED blinks blue, the Sensor is connected and ready to place.

If it blinks red, try the test again. You may find that repositioning the Sensor (even just a few inches) can improve reception.

i If the Sensor cannot connect, try installing a Ring Range Extender between your Sensor and Base Station.

Close the lid.

Place the lid back on the Sensor, taking care to line up the semi-circle on the rim of the lid with the "open" semi-circle on the base. Twist the lid clockwise to lock it in.

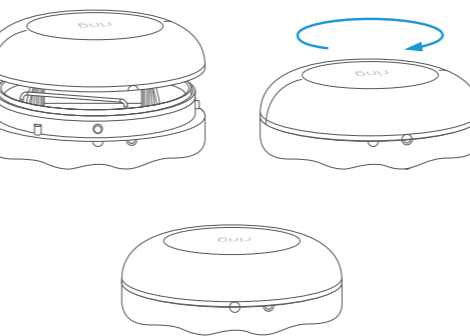

Place the Sensor on the ground.

Choose a spot next to a possible source of flooding, such as your water heater, sink, or refrigerator. Take care to place the Sensor in a location where it won't be kicked or moved unintentionally.

i If the surface you're placing on is not flat, try to place your Sensor at the lowest point.

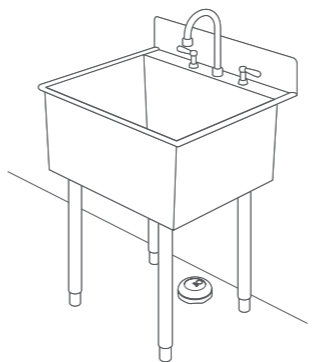

4. Additional information.

How to remove this Sensor from your system:

Open the side menu in the Ring app and tap **Devices**, then **Base Station**. Next, select your Sensor, then tap the gear-shaped icon, and tap **Remove Device**.

When prompted, open the sensor and remove and reinstall the battery to complete the removal.

Having trouble with your Sensor?

If your Flood & Freeze Sensor stops working or can't connect (even with a good battery), try a factory reset.

To do this, press and hold the Setup button for 10 seconds. When the LED ring stops blinking, the Sensor has reset.

i This process disconnects the Sensor from Ring Alarm. To begin using the Sensor again, repeat the setup process in the Ring app.

How to replace the battery:

Twist the lid on the Sensor counter-clockwise and lift to remove. Replace the battery with a fresh CR123A cell.

The Sensor then reconnects to your Ring Base Station automatically.

LED status patterns:

Water or low temperature detected  Blue Blink (1x)

Sensor tampered  Red Blinks (3x)

For info on other LED patterns, visit ring.com/help.