



# MAESTRO™

ORCHESTRATING COMFORT



USER GUIDE

**SMART THERMOSTAT**

Model: SMT402

# TABLE OF CONTENTS

COMPATIBILITY	3	THE 360° COMFORT EXPERIENCE	21
WHAT'S IN THE BOX AND TOOLS REQUIRED	3	Make the most of your MAESTRO	21
WARNING	4	Control your comfort from wherever you are	21
Where to install your MAESTRO controller•thermostat	5	Group rooms	21
Read this guide and watch the installation video	5	Create personalized activities	21
INSTALLING THE MAESTRO THERMOSTAT	6	Anticipated start	21
① Cut off power supply	6	Geofencing: comfort follows you wherever you go	21
② Remove existing thermostat	7	Track your energy consumption	21
③ Secure the MAESTRO thermostat mounting plate	8	THERMOSTAT TROUBLESHOOTING	22
④ Connect the wires	9	Common problems	22
⑤ Secure the thermostat on the mounting plate	10	THERMOSTAT DEFAULT VALUES	24
⑥ Turn power back on	11	TECHNICAL SPECIFICATIONS	25
⑦ Set-up basic options on first start	12	Electrical data	25
USING THE THERMOSTAT	13	Temperature display	25
Thermostat interface	13	Connectivity	25
Navigating the advanced menus	14	Storage and operating conditions	25
Advanced menus	14	WARRANTY	26
Navigating the °STELPRO menu	15		
Setting the heating mode	15		
Connecting a thermostat to the MAESTRO controller•thermostat	16		
With the MAESTRO app	16		
Without the MAESTRO app	17		
Connecting the thermostat to another Zigbee network	18		
Setting the temperature setpoint	18		
Displaying ambient relative humidity or outdoor temperature	19		
Choosing the temperature display unit (°C or °F)	19		
Locking or unlocking the keypad	19		
Activating or deactivating open window detection	20		
Activating or deactivated proximity detection	20		
Resetting the thermostat	20		

# COMPATIBILITY

Your MAESTRO controller • thermostat can control electric baseboards, convectors and fan-forced heaters.

**IMPORTANT:** This thermostat is not compatible with:

- Systems with inductive loads
- Central heating systems
- Systems with resistive loads that are:
  - inferior to 150 W at 120 VAC / 260 W at 208 VAC / 300 W at 240 VAC
  - superior to 2000 W at 120 VAC / 3400 W at 208 VAC / 4000 W at 240 VAC

See [page 25](#) for detailed technical specifications of the MAESTRO thermostat.

## WHAT'S IN THE BOX AND TOOLS REQUIRED

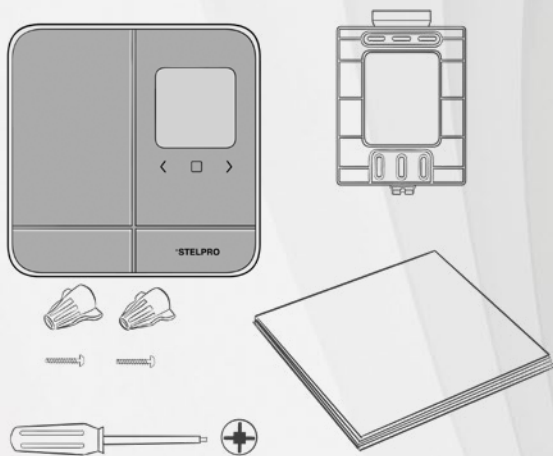

- MAESTRO thermostat
- Mounting plate
- Mounting screws (2)
- Caps (2)
- Quickstart guide
- Warning

To install your thermostat, you will need:

- No. 2 Phillips screwdriver

The two required screws are supplied.

# WARNING

Before installing and operating this thermostat, the owner and/or installer must read, understand and follow these instructions and keep them handy for future reference. If these instructions are not followed, the warranty will be considered null and void and the manufacturer deems no further responsibility for this product. Moreover, the following instructions must be adhered to in order to avoid personal injuries or property damages, serious injuries and potentially fatal electric shocks. All electric connections must be made by a qualified electrician, according to the electric and building codes effective in your region.

- Do NOT connect this product to a supply source other than 120 VAC or 240 VAC, and do not exceed the load limits specified.
- Protect the heating system with the appropriate circuit breaker or fuse. You must regularly clean dirt accumulations on the thermostat.
- Do NOT use fluid to clean thermostat air vents.
- Do NOT install thermostat in a wet place or on an external wall. However, installing it in isolated walls is allowed. To avoid any risk of overheating, leave a clearance of at least 30 cm (12 in.) around the thermostat to ensure proper ventilation.
- Also, make sure that the air vents at the bottom and top of the thermostat housing are clear of any obstruction: blocked air vents can lead to the unit overheating and affect its operation.

NOTE: °STELPRO reserves the right to modify its product without notice to improve operability. Therefore, the instructions in this user guide may not entirely match all the functions of your thermostat. To obtain the most recent documentation, visit the °STELPRO website.

**IMPORTANT:** HIGH VOLTAGE! CUT OFF POWER BEFORE INSTALLING UNIT OR DOING ANY MAINTENANCE.

## WHERE TO INSTALL YOUR MAESTRO CONTROLLER • THERMOSTAT

Install a MAESTRO thermostat in each room where you want to control the temperature.

You must install the thermostat at approximately 1.5 m (5 ft.) from the floor, on an indoor wall that faces the heating system. The thermostat must be mounted on an electrical box.

**ATTENTION:** To avoid any risk of overheating, leave a clearance of at least 30 cm (12 in.) around the thermostat to ensure proper ventilation. Also, the front of the unit should be completely clear of any obstruction to ensure optimal functionality. For example, do not install the thermostat behind curtains or furniture.

To avoid getting false temperature measurements, do not install the thermostat in any of the following locations:

- Near a window or close to a door leading outside
- In an area exposed directly to the light or heat of the sun, a lamp, a fireplace or any other heat source
- Near an air outlet
- Near concealed ducts or a chimney
- Where there is poor air flow (e.g. behind a door)
- Where there is a high concentration of dust
- Where there are frequent air drafts (e.g. top of stairs)

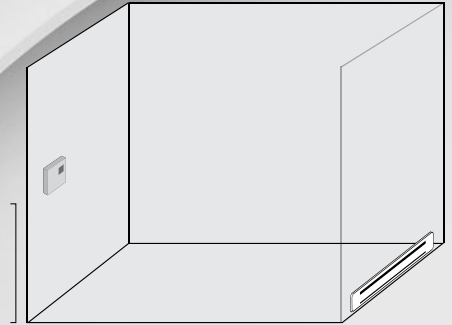

## READ THIS GUIDE AND WATCH THE INSTALLATION VIDEO

Before you start, take a few minutes to carefully read this guide and watch the step-by-step video on installing the MAESTRO thermostat. It will ensure safe and easy installation.

The installation video is at the bottom of this page: [www.stelpro.com/en-CA/maestro](http://www.stelpro.com/en-CA/maestro)

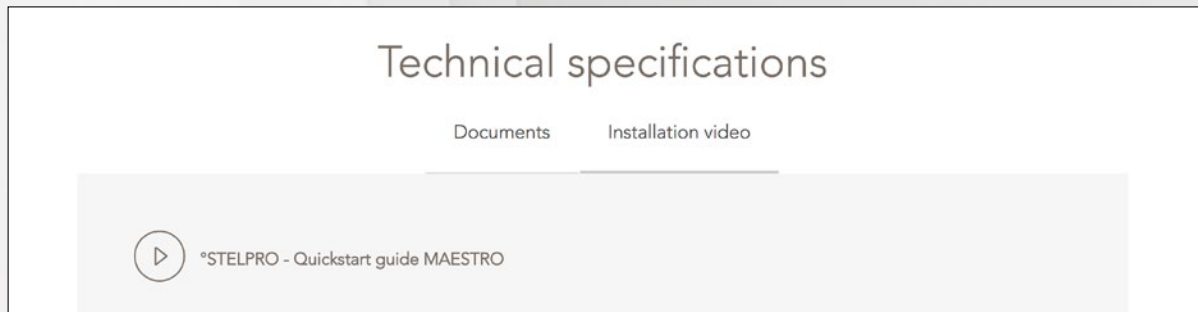

# INSTALLING THE MAESTRO THERMOSTAT

## IMPORTANT

INSTALLATION OF THE THERMOSTAT MUST BE DONE BY A QUALIFIED ELECTRICIAN.

### 1 CUT OFF POWER SUPPLY

To avoid any risk of electric shock, cut off the power supply on the lead wires from the electrical panel. Make sure the power is off by checking, for example, that the heating system remains off even if the setpoint temperature is higher than the ambient temperature (mechanical thermostat).

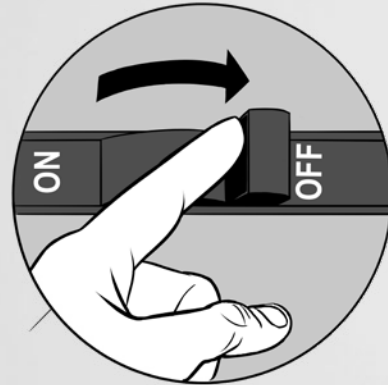

## 2

### REMOVE EXISTING THERMOSTAT

If an existing thermostat is being replaced, remove it and disconnect its wires from the heating system and power supply.

**NOTE:** These instructions apply to a thermostat with a °STELPRO mounting plate.

- 1- Loosen the screw at the base of the thermostat, without completely removing it, to separate the thermostat from the mounting plate.
- 2- Gently pull the thermostat to gain access to the wires.
- 3- Disconnect the thermostat wires from those of the heating system and power supply.
- 4- Remove the mounting plate.



# 3

## SECURE THE MAESTRO THERMOSTAT MOUNTING PLATE

Secure the MAESTRO thermostat mounting plate to the electrical box using the screws supplied.

- 1- Loosen the screw at the base of the MAESTRO thermostat, without completely removing it, until the thermostat and the mounting plate are no longer holding together.
- 2- Slide the mounting plate downward and then pull on it to separate it from the thermostat.
- 3- Using the mounting screws supplied (2), secure the MAESTRO thermostat mounting plate to the electrical box. Ensure the plate is perfectly straight so that the thermostat is also straight.
- 4- Pass the power supply wires through the large opening at the centre of the mounting plate.

**NOTE:** You can position the mounting plate either to the left, in the centre or to the right of the electrical box, according to your needs. (See image below).

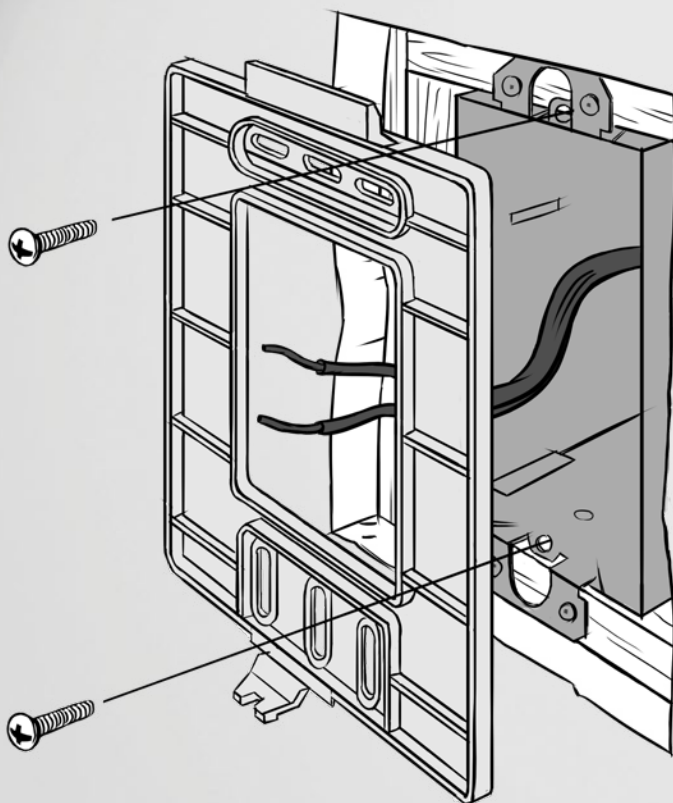



# 4

## CONNECT THE WIRES

Using the caps supplied (2), connect the wires of the MAESTRO thermostat to those of the heating system and power supply according to the corresponding connection diagram (2 or 4 wires). Tighten the caps onto the wires to ensure the connection is secure. Then place all the wires inside the electrical box.

**NOTE:** If the electrical wires are aluminum, use CO/ALR connectors instead (not supplied).

**NOTE:** Since thermostat wires do not have polarity, the way they are connected is not important.

### IMPORTANT

IMPROPER WIRING IS  
A FIRE HAZARD.

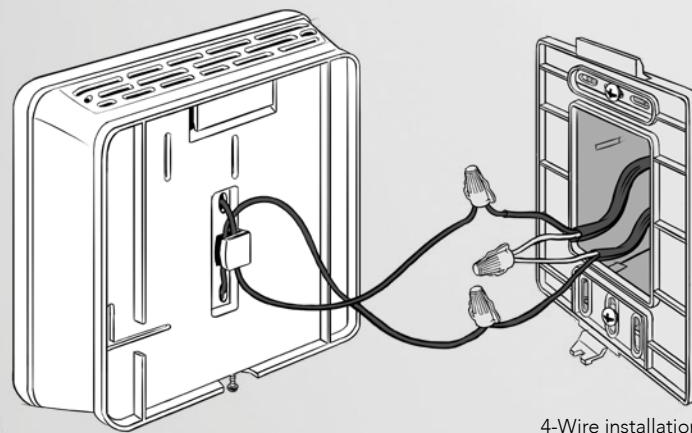
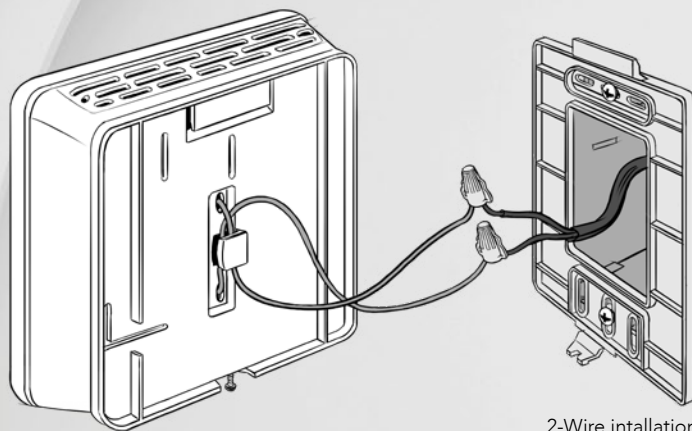

## 5 SECURE THE THERMOSTAT ON THE MOUNTING PLATE

Align and secure the thermostat on the mounting plate.

- 1- Ensure the air vents in the thermostat are clean and clear of any obstruction.
- 2- Align the slot on the top of the thermostat with the slot on the mounting plate.
- 3- Then secure the thermostat to the mounting plate making sure that the wires do not get pinched between the unit and the mounting plate.
- 4- Tighten the screw at the base of the thermostat to secure it in place.

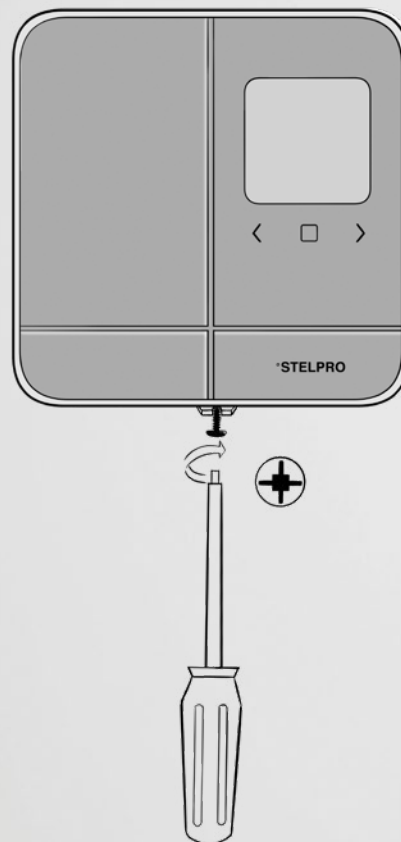
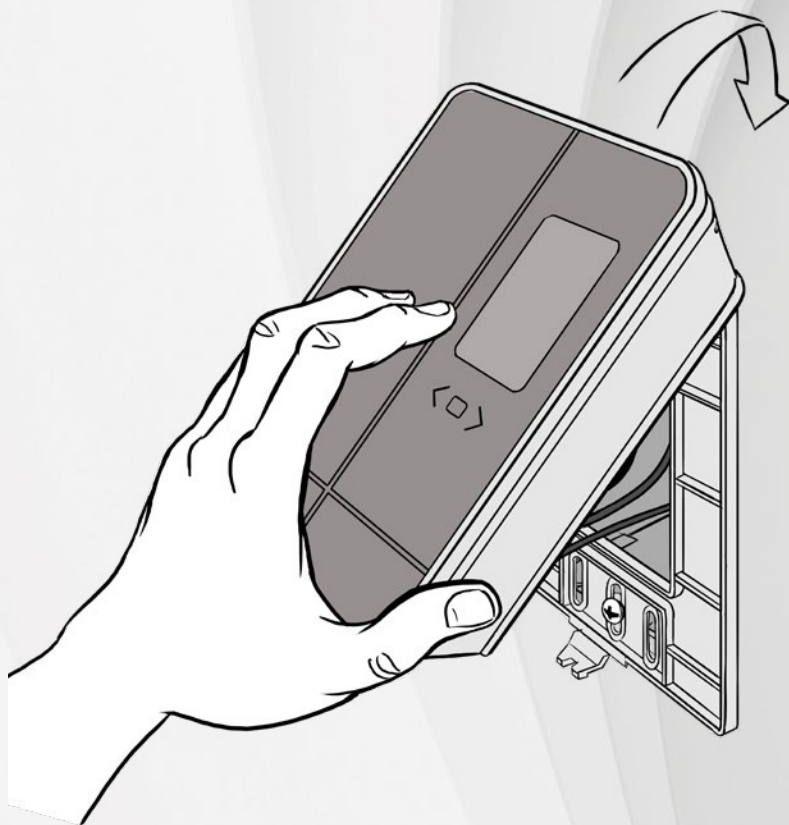

## 6 TURN POWER BACK ON

Restore power to the heating system and thermostat. Then ensure the thermostat turns on.

If the thermostat does not turn on, touch any one of its buttons. The thermostat should turn on. If it doesn't, read the Thermostat troubleshooting section on [page 22](#).

At first power up, the thermostat will ask you to set-up the basic options. If it is not the first power up, the thermostat displays the ambient temperature as well as the percentage of relative ambient humidity. If the temperature is below 0°C (32°F), the home screen will display LO. If the temperature exceeds 50°C (122°F), the screen will display HI.



## 7 SET-UP BASIC OPTIONS ON FIRST START

2 settings to be set:

- > Temperature format (°Celsius / °Fahrenheit)
- > HEATING MODE (Baseboard / Fan-forced heater)

Use the LEFT/RIGHT arrows to change the selection and used CENTER button to confirm.

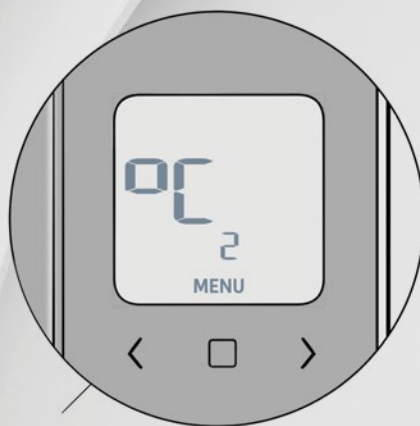

TEMPERATURE FORMAT

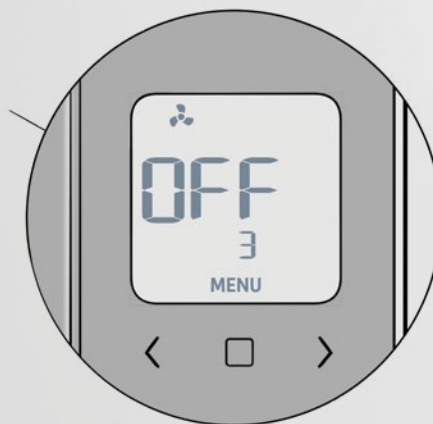
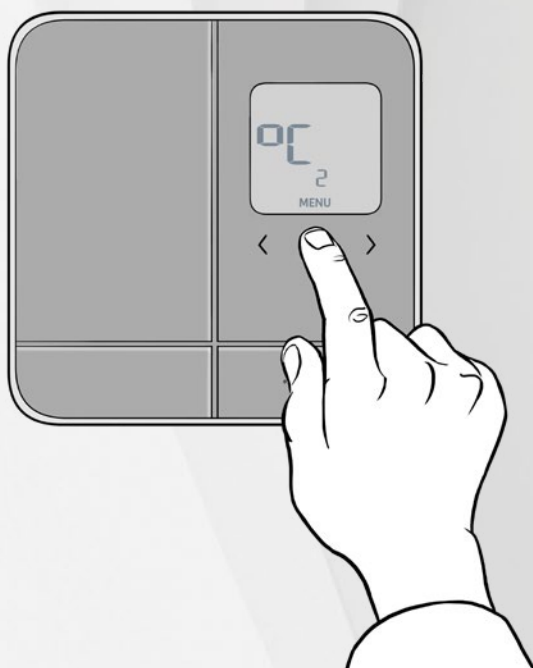

HEATING MODE

# USING THE THERMOSTAT

As soon as your thermostat is installed, set the heating mode. If you want to connect your thermostat to a MAESTRO controller•thermostat, you must also set up the Zigbee connection. Install all your thermostats before connecting them to the controller•thermostat.





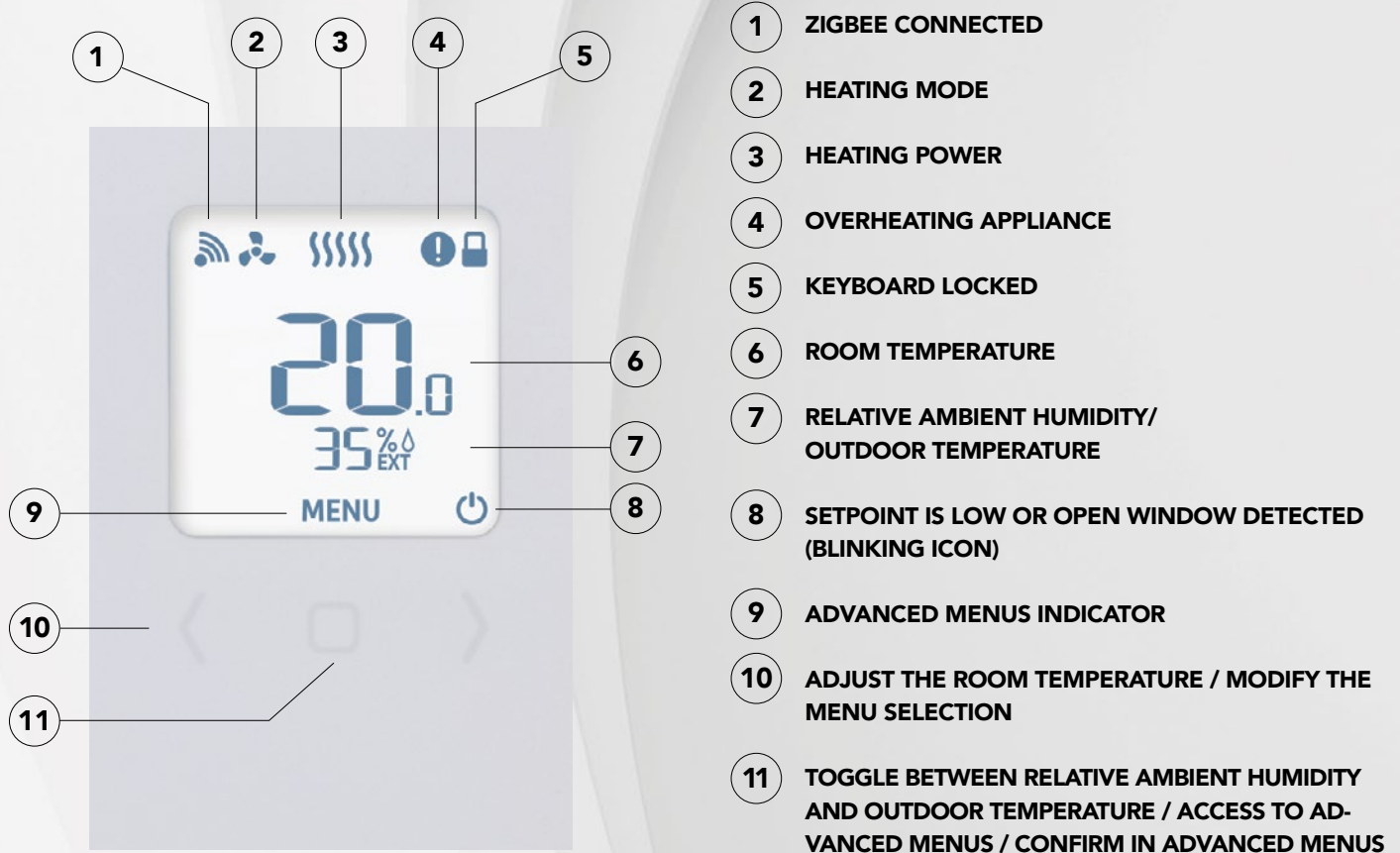

## THERMOSTAT INTERFACE

MAESTRO three-button interface makes 360° comfort possible.







## NAVIGATING THE ADVANCED MENU

To access the advanced menus and their options:

- 1- Touch the  button for three seconds to access the advanced menus. The first menu you'll access is the Zigbee connection menu.
- 2- Touch the  button again to access the next menu. The current value will flash, indicating that it can be modified.
- 3- Use the  and  buttons to select another option for the displayed menu.
- 4- After selecting an option, touch the  button to confirm the selection. The selected value will flash rapidly for two seconds, then appear continuously once it is saved. Then, the thermostat automatically switches to the next menu.
- 5- Touch the  button for three seconds to exit the advanced menus and return to the thermostat's home screen.

**NOTE:** After 30 seconds of inactivity, the selected option is automatically saved (except for menu 1 – Zigbee connection) and the thermostat returns to the home screen.

### Advanced menus

- Menu 1: Zigbee connection (  )
- Menu 2: Temperature display (°C or °F)
- Menu 3: Heating mode (  )
- Menu 4: Locking/Unlocking the keypad (  )
- Menu 5: Open window detection (  )
- Menu 6: Proximity detection
- Reset Menu (DEF)

## NAVIGATING THE °STELPRO MENU

---



To access the °STELPRO menu touch the  button on the home screen for ten seconds.

**NOTE:** After three seconds, the advanced menus will display (menu 1). Continue touching the button until the °STELPRO menu appears.

The °STELPRO menu's sub-menus provide information about the thermostat.

- **t1:** Thermostat version (e.g., if the thermostat displays 14, you have version 1.4 of the thermostat)
- **t2:** Zigbee radio version (e.g., if the thermostat displays 10, you have version 1.0 of the radio)
- **t3:** Date manufactured
- **t4:** Month manufactured
- **t5:** Year manufactured
- **t6:** Control code in baseboard mode (information reserved for °STELPRO)
- **t7:** Control code in fan mode (information reserved for °STELPRO)



To navigate the °STELPRO menu:

- Use the  button to switch from one item to the next.
- Touch the  button for three seconds to exit the °STELPRO menu and return to the thermostat's home screen

## SETTING THE HEATING MODE

---

The heating mode corresponds to the type of heating system the thermostat controls: baseboard convactor or fan convactor. Select the heating mode as soon as you finish installing the thermostat.

- 1-** Access menu 3.
- 2-** Use the  and  buttons to select the baseboard convactor (OFF) or fan convactor (ON) mode.
- 3-** Touch the  button to confirm your selection.

When the fan convactor mode is selected, the  icon displays on the thermostat's home screen.

## CONNECTING A THERMOSTAT TO THE CONTROLLER•THERMOSTAT

To create your MAESTRO account, you must connect your thermostats to the MAESTRO controller•thermostat using a Zigbee network. Make sure to connect the thermostat closest to the MAESTRO controller thermostat first and then each of the other thermostats by gradually working outwards.

### With the MAESTRO app

**NOTE:** To connect a thermostat to the MAESTRO controller•thermostat using the MAESTRO app, your controller•thermostat must be linked to a Wi-Fi network (see [www.stelpro.com/en-CA/support-maestro](http://www.stelpro.com/en-CA/support-maestro)). You may need a Zigbee repeater to get around obstacles or to strengthen the Zigbee signal.

- 1- In the MAESTRO app, access **HOME SETTINGS**, from the groups and settings screen, and tap **CONNECT A THERMOSTAT TO MY MAESTRO SYSTEM**. The screen **ADD A NEW THERMOSTAT** on the controller•thermostat will display the Zigbee channel being used.
- 2- On the thermostat, access menu 1 and select the channel displayed by the controller•thermostat. You can also use the auto-connect option (ON), but the connection may take more time.
- 3- On the thermostat, tap the  icon to confirm the selection. The  icon will blink rapidly while the thermostat searches for the channel. The Zigbee channel will appear when the connection is established.

When the thermostat is connected to the controller•thermostat's Zigbee network:

- The  icon will appear on the thermostat home screen.
- A message confirming the connection will appear on the controller•thermostat's screen.
- The MAESTRO app will show that the thermostat has been successfully connected and the thermostat will appear in the app. You can now replace the default name of each thermostat by a meaningful name that is easily recognizable (e.g. bathroom).



If the thermostat does not detect a Zigbee network, an "Err" message will display on the thermostat.





## Without the MAESTRO app

The thermostat can be connected to the controller • thermostat even if the controller • thermostat is not linked to a Wi-Fi network.

- 1- On the controller • thermostat, access **SETTINGS**  > **ZIGBEE SETUP** > **ADD A NEW THERMOSTAT**. The screen **ADD A NEW THERMOSTAT** on the controller • thermostat will display the Zigbee channel being used.
- 2- On the thermostat, access menu 1 and select the channel displayed by the controller • thermostat. You can also use the auto-connect option (ON), but the connection may take more time.
- 3- On the thermostat, tap the  button to confirm the selection. The  icon will blink rapidly while the thermostat searches for the channel. The Zigbee channel will display them when the connection is established.

When the thermostat is connected to the controller • thermostat's Zigbee network, the  icon will appear on the home screen.

If the thermostat does not detect a Zigbee network, an "Err" message will appear on the thermostat.



< **ADD A NEW  
THERMOSTAT**

Put new thermostat  
in pairing mode  
on channel : 15



## CONNECTING THE THERMOSTAT TO ANOTHER ZIGBEE NETWORK



If you do not have a MAESTRO controller•thermostat, but your home already has a Zigbee network, you can connect the thermostat to this network. However, you won't be able to use the MAESTRO app or benefit from all the MAESTRO system advantages.

- 1- Set the thermostat control device to Zigbee connection mode.
- 2- From the thermostat, access menu 1 and select the channel indicated by the control device. You can also use the automatic connection (ON) option, but the connection will take longer. With the auto-connect option, the  icon flashes quickly while the thermostat searches for the channel. The Zigbee channel is displayed when the connection is established.
- 3- Touch the  button to confirm your selection.

Once the thermostat is connected to the Zigbee network, the  icon will display on the home screen.

If the thermostat does not detect a Zigbee network, the "Err" message will display on the thermostat.

## SETTING THE TEMPERATURE SETPOINT

By default, the temperature setpoint is set to 21 °C (70°F). To change the temperature setpoint, use the  and  on the home screen.

The  button will increase the temperature setpoint by 0.5°C (1 °F) at a time.

The  button will lower the temperature setpoint by 0.5°C (1 °F) at a time.

If the thermostat must activate the heating system to reach the temperature setpoint, the icon  indicates the intensity at which the heating system is working.

**NOTE:** If the thermostat is part of a MAESTRO system that includes a controller•thermostat, the temperature will adjust automatically if the status of the home changes or if a thermostat-related activity begins.

**NOTE :** The thermostat keypad must be unlocked (i.e.  icon not displayed on the screen).



## DISPLAYING AMBIENT RELATIVE HUMIDITY OR OUTDOOR TEMPERATURE

In addition to room temperature, the home screen displays the percentage of ambient relative humidity by default. On the home screen, touch the  button to switch the ambient humidity display to outdoor temperature.

**NOTE :** NOTE: Outdoor temperature display is possible only if your thermostat is connected to a MAESTRO controller • thermostat linked by Wi-Fi to an internet connection and you have geofenced your home using the MAESTRO app.

## CHOOSING THE TEMPERATURE DISPLAY UNIT (°C OR °F)



By default, the temperature is displayed in degrees Celsius. You can also display the temperature in degrees Fahrenheit.

- 1- Access menu 2.
- 2- Use the  and  buttons to select °C or °F.
- 3- Touch the  button to confirm the selection.

**Tip:** If you change the display unit directly on the controller • thermostat, the change will be applied to all your other thermostats automatically.

## LOCKING OR UNLOCKING THE KEYPAD

You can lock the thermostat keypad to prevent the set temperature from being changed by mistake. By default, the thermostat keypad is unlocked.

- 1- Access menu 4.
- 2- Use the  and  buttons to unlock (OFF) or lock (ON) the keypad.
- 3- Touch the  button to confirm your selection.

When the keypad is locked, the  icon displays on the thermostat's home screen.

**NOTE:** You can change a thermostat's temperature setpoint with the controller • thermostat or the MAESTRO app even if the keypad is locked.

## ACTIVATING OR DEACTIVATING OPEN WINDOW DETECTION

---

By default, the thermostat will detect if a window is open in the room where it is located, and the thermostat automatically adjusts the set temperature to 7°C (45°F) to avoid heating the room unnecessarily.

- 1- Access menu 5.
- 2- Use the  and  buttons to activate (ON) or deactivate (OFF) open window detection.
- 3- Touch the  button to confirm the selection.

## ACTIVATING OR DEACTIVATED PROXIMITY DETECTION

---

By default, the thermostat screen automatically turns on when it detects a presence nearby. You can deactivate this feature, to prevent the thermostat from turning on every time you enter a child's room, for example. When this feature is deactivated, simply touch one of the thermostat buttons to turn on the screen.

- 1- Access menu 6.
- 2- Use the  and  buttons to activate (ON) or deactivate (OFF) proximity detection.
- 3- Touch the  button to confirm the selection.

## RESETTING THE THERMOSTAT

---

You can reset the thermostat to restore its default settings.

- 1- Access the Reset menu (DEF).
- 2- Use the  and  buttons to select "Y" and revert to default values.
- 3- Touch the  button to confirm the reset.

The thermostat may take a few seconds to reset.

## IMPORTANT

ALL PARAMETERS RETURN TO THEIR DEFAULT VALUE AND THE CONNECTION TO THE ZIGBEE NETWORK AND THE CONTROLLER•THERMOSTAT IS DELETED. THE CONTROLLER•THERMOSTAT STILL DISPLAYS THE THERMOSTAT, EVEN IF IT CAN NO LONGER CHECK IT. THEREFORE, YOU MUST DELETE THE CONTROLLER•THERMOSTAT MANUALLY (SEE THE MAESTRO CONTROLLER•THERMOSTAT INSTALLATION AND USER GUIDE).

# THE 360° COMFORT EXPERIENCE

## MAKE THE MOST OF YOUR MAESTRO

The MAESTRO thermostat can function on its own, but it offers more options when used with MAESTRO controller• thermostat and the MAESTRO app. By using the complete MAESTRO system, you'll benefit from maximum comfort, flexibility and energy savings.

For more information on the MAESTRO system, visit [www.stelpro.com/en-CA/maestro](http://www.stelpro.com/en-CA/maestro).

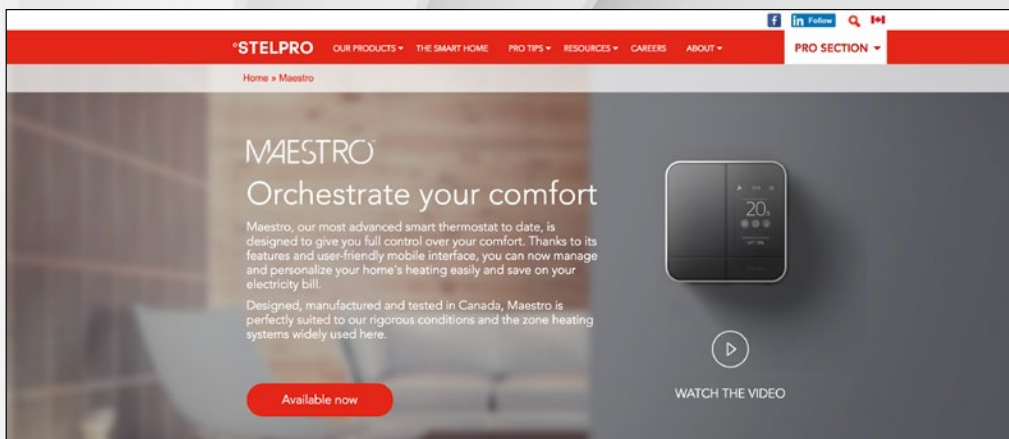

## CONTROL YOUR COMFORT FROM WHEREVER YOU ARE

### GROUP ROOMS

You can set up zones in your home to make managing your heating even simpler.

### CREATE PERSONALIZED ACTIVITIES

Planning an in-home workout session or movie night? Create an activity and MAESTRO will adjust the temperature of your rooms at the right time.

### ANTICIPATED START

MAESTRO takes into account the outside temperature to reach the desired temperature at the perfect time.

### GEOFENCING:

### COMFORT FOLLOWS YOU WHEREVER YOU GO

The MAESTRO app adjusts the temperature of your home according to your geographic location, to ensure ideal comfort when you arrive and lowering it when you leave.

### TRACK YOUR ENERGY CONSUMPTION

By giving you access to real-time reports, MAESTRO keeps you informed of your energy consumption, helping you achieve real savings.

# THERMOSTAT TROUBLESHOOTING

## COMMON PROBLEMS



The following table lists the most common problems and alerts that you may encounter with your thermostat.

If your problem does not appear in this table or if the suggested solutions do not solve the problem, visit the support section on our website ([www.stelpro.com/en-CA/support-maestro](http://www.stelpro.com/en-CA/support-maestro)) or contact our customer service team at:

1-866-628-5776

450-441-6988

[s.technique@stelpro.com](mailto:s.technique@stelpro.com)

PROBLEM / ALERT	SOLUTION
 blinking	The heating system is overheating. Inspect your heating system and replace it if it is defective.
 blinking	The thermostat has detected an open window. Close the window or disable open window detection.
 blinking	There's a problem with the thermostat's Zigbee network. Reset the thermostat and reconnect it to the controller • thermostat. See Connecting the thermostat to the MAESTRO controller • thermostat.
LO	The room temperature is below 0°C (32°F). Heating will remain active until the temperature reaches the setpoint. The LO message will disappear when the temperature reaches 0°C (32°F).
HI	The room temperature exceeds 50°C (122°F). Heating will remain inactive. The HI message will disappear when the temperature reaches 50°C (122°F).
--	The thermostat cannot measure the temperature (temperature sensor is defective). Replace the thermostat. <b>NOTE:</b> This alert may also display temporarily after you do a reset. It should disappear on its own after approximately 10 seconds.
The thermostat is hot to the touch.	Even when operating normally, the thermostat's housing can become hot to the touch. This does not affect the thermostat's efficiency or performance.
Heating is always on, even when the setpoint temperature has been reached.	Make sure the wires of the thermostat are properly connected. (See instructions in Installing the MAESTRO thermostat on <a href="#">page 6</a> ). <b>NOTE:</b> The thermostat can also control residual heating to maintain the temperature once the setpoint has been reached.
Heating system does not run even though the thermostat indicates it is on.	Make sure the wires of the thermostat are properly connected. (See instructions in Installing the MAESTRO thermostat on <a href="#">page 6</a> ).

<p>The thermostat does not light up after being installed.</p>	<p>Make sure the wires of the thermostat are properly connected and that the caps are tightened (see instructions in "Installing the MAESTRO thermostat" on <a href="#">page 6</a>).</p> <p>Make sure the circuit breaker associated with the heating system in the electrical box is OFF.</p> <p>If the heating system has a switch, make sure it is ON.</p>
<p>The thermostat is not displaying the correct ambient temperature.</p>	<p>Make sure there are no drafts or sources of heat near the thermostat.</p>
<p>The fan heater turns on and off frequently.</p>	<p>In the heating mode menu (3), select <b>ON</b>.</p>
<p>The connection icon on the home screen is flashing.</p>	<p>There's a problem with the Zigbee radio module. Reset the thermostat and reconnect it to the (Zigbee) controller•thermostat.</p>
<p>The buttons do not respond, except for advanced menu access.</p>	<p>The thermostat is locked. Deactivate lock mode.</p>
<p>The thermostat doesn't connect to the Zigbee network.</p>	<p>Your thermostat may be too far from another thermostat in the network. Make sure that the thermostats between this thermostat and the controller•thermostat are installed and connected to the Zigbee network.</p> <p>Also make sure that the controller•thermostat is in connection mode and that you have selected the correct channel.</p>

# THERMOSTAT DEFAULT VALUES

Setpoint temperature	21.0°C (70°F)
Additional display	Ambient humidity
Zigbee connection	Disconnected
Temperature format	Degrees Celsius
Heat mode	Baseboard
Locking	Keyboard unlocked
Open window detection	Activated
Proximity sensor	Activated



# TECHNICAL SPECIFICATIONS

## ELECTRICAL DATA

Supply voltage	120/240 VAC, 50/60 Hz
Minimum load	Resistive only 150 W to 120 VAC, 50/60 Hz 260 W to 208 VAC, 50/60 Hz 300 W to 240 VAC, 50/60 Hz
Maximum load	Resistive only 2000 W to 120 VAC, 50/60 Hz 3400 W to 208 VAC, 50/60 Hz 4000 W to 240 VAC, 50/60 Hz

## TEMPERATURE DISPLAY

Actual measured temperature	0°C to 50°C (32°F to 122°F)
Temperature display increments	0.5°C (1°F)
Temperature setpoint	5°C to 30°C (41°F to 86°F)
Temperature setpoint increments	0.5°C (1°F)

## CONNECTIVITY

Zigbee	IEEE 802.15.4 protocol
--------	------------------------

## STORAGE AND OPERATING CONDITIONS

Storage temperature	-40°C to 50°C (-40°F to 122°F)
Operating temperature	-20°C to 50°C (-4°F to 122°F) The efficiency of the LCD screen may decrease below 0°C (32°F)
Relative humidity	5 % to 95 % without condensation

# WARRANTY

This unit has a 3-year warranty. If at any time during this period the unit fails to function properly, you must return it to the place of purchase with the invoice copy, or simply contact our customer service department (with an invoice copy in hand). In order for the warranty to be valid, the unit must have been installed and used according to instructions. If the installer or the user modifies the unit, he/she will be held responsible for any damage resulting from this modification. The warranty is limited to the factory repair or the replacement of the unit, and does not cover the cost of disconnection, transport and installation.

Email: [contact@stelpro.com](mailto:contact@stelpro.com)

Website : [www.stelpro.com](http://www.stelpro.com)

