

Fan Coil Thermostat (2-pipe)

MH8-FC-EU

Introduction

MCOHome Fan Coil Thermostat is a Z-Wave enabled device for indoor temperature control. It is mainly applied to a 2-pipe Fan coil system. It can read room temperature and local time, and automatically control fan speed based on the temperature difference. The device is of high reliability and practicability. This product can be included and operated in any Z-Wave network with other Z-Wave certified devices from any other manufacturers.

Features:

- Capacitive touch buttons
- Tempered glass panel, PC alloy enclosure
- Precise temperature calibration function
- Non-volatile Memory, working state saved even power failure
- Intelligent on/off control of 3-speed fan, electric (ball) valve or air-valve
- Easily steel frame back plate installation



Specification

- Power Supply: AC85V~260V, 50/60HZ
- Resistive Load: $\leq 3A$
- Self Consumption: $< 1W$
- Temperature Sensor: NTC 15K
- Display Accuracy: 0.1 °C
- Working Environment: 0~55°C; $< 95\% RH$ (Non-condensation)
- Temperature Setting: 5~35 °C (Adjustable)
- Dimension: 86* 86*42mm
- Hole Pitch: 60-65mm (86 Standard junction box)
- Z-Wave Frequency: 868.42MHz (EU)

Safety Information

To protect yourself and others from danger and to protect the device from damage, please read the safety information before using it.

Important!

- A qualified electrician with the understanding of wiring diagrams and knowledge of electrical safety should complete installation following the instructions.

- Before installation, please confirm the real voltage complying with the device’s specification. Cut off any power supply to secure the safety of people and device.
- During installation, protect the device from any physical damage by dropping or bumping. If happens, please contact the supplier for maintenance.
- Keep the device away from acid-base and other corrosive solids, liquids, gases, to avoid damage.
- Avoid overexertion during operation, to protect device from mechanical damage.
- Read all instructions and documentation and save for future reference.

Installation & Wiring

Location:

Thermostat is suggested to be installed indoor, a place with around 1.5m height above the floor where represents the average room temperature. It should be away from direct sunlight, any cover, or any heat source, to avoid false signal for temperature control.

CAUTION: *Cut off power supply at circuit breaker or fuse before installation to avoid fire, shock or death!*

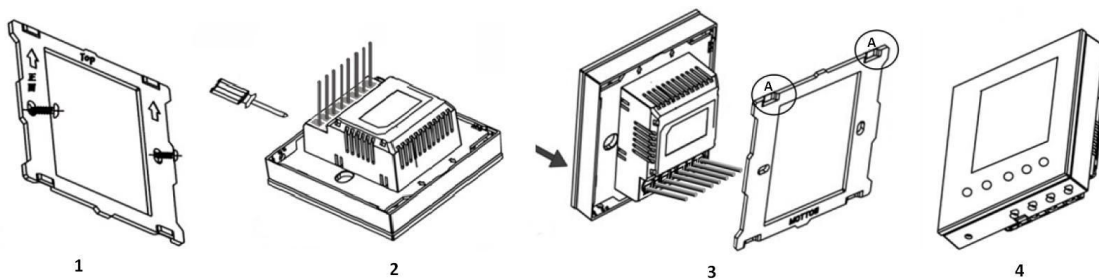

- Step 1:** Remove the steel frame from the device, and secure it onto the junction box with two screws.
- Step 2:** Insert all wires into the right terminals and tighten screws. The wiring diagram is shown below.
- Step 3:** Attach the wired device on “A” points of the steel frame as shown first, and then push the whole device into junction box.
- Step 4:** Confirm the device is well mounted, power on and it is ready to operate.

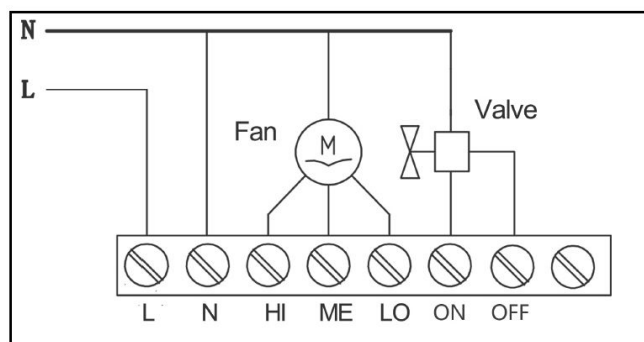

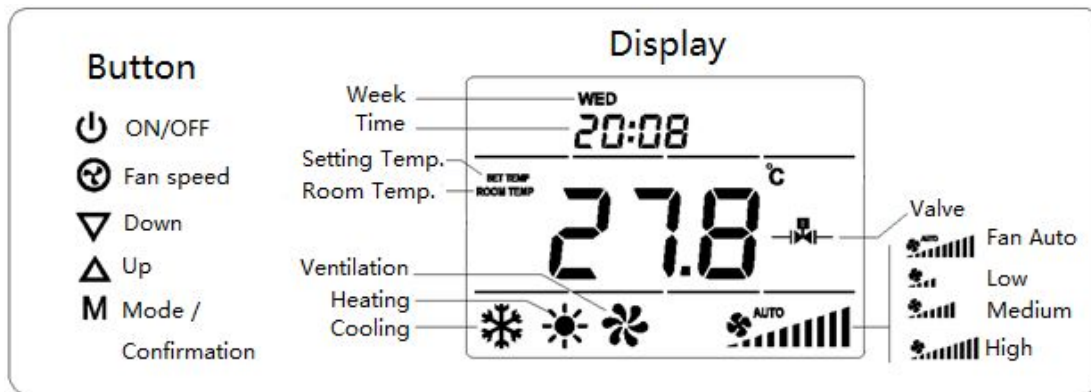

Button & Display





Operation





On/Off Setting

When power on, thermostat will display “OFF”, press  to enter working interface.
When normal working, press  turn off the device, “OFF” displays and all outputs are off.



Local Time Setting

Press & hold “M” to enter local time setting. Touch “M” to switch among Week, Hour & Minute, and then press  or  to set the parameters of flashing item. Press “M”, or wait for 15s to save the value and return to display.

Working Mode Setting

Touch “M” to enter working mode setting, the current mode flashing. Press  or  to switch among Cooling , Heating  & Ventilation  mode, then press “M”, or wait for 15s to confirm the choice.

Temperature setting

Touch  or  to set local temperature value. Hold the buttons can set continuously. Press “M”, or wait for 15s to save and return to room temperature display.

Fan Speed setting

In normal display, press  to switch among the fan speed :“ Low, Medium, High, Auto” ; Then press “M”, or wait for 15s to confirm the choice.

Note: In Ventilation mode, no Auto speed choice.

● Fan Manually control

If fan speed is manually set , the device still auto control the fan in such situation:

Cooling Mode:

- Room temperature \leq setting temperature, valve closes and fan stops;
- Room temperature \geq setting temperature +1 °C, valve and fan opens.

Heating Mode:

- Room temperature \geq setting temperature, valve closes and fan stops;
- Room temperature \leq setting temperature -1 °C, valve and fan opens.

● **Fan Automation**

Cooling Mode	<p>a. Room temperature \leq setting temperature, valve closes automatically, fan stops;</p> <p>b. Room temperature \geq setting temperature +1 °C, fan turned on in low speed;</p> <p>c. Room temperature \geq setting temperature +2 °C, fan turned on in medium speed;</p> <p>d. Room temperature \geq setting temperature +3 °C, fan turned on in high speed;</p>
Heating Mode	<p>a. Room temperature \geq setting temperature, valve closes automatically, fan stops;</p> <p>b. Room temperature \leq setting temperature -1 °C, fan turned on in low speed;</p> <p>c. Room temperature \leq setting temperature -2 °C, fan turned on in medium speed;</p> <p>d. Room temperature \leq setting temperature -3 °C, fan turned on in high speed;</p>

Note: Fan will operate only if the valve opens.

Parameter Setting

● **Power Failure Memory**

Under the shutdown state, press & hold  will enter interface for power failure memory selection, “PAGE” displays. Press Δ or ∇ to change setting value, then press “M” to confirm and return.

After power failure:

000 (default) indicates device will be in shutdown state (“OFF”) when power on again;

001 indicates device will be in working interface when power on again;

002 indicates device will stay the status before power failure when power on again.

● **Temp. Calibration/ Temp. Setting Range**

Under the shutdown state, press & hold Δ will enter interface for temperature calibration, “-ERR” displays. The calibration range is among -5.0 ~ +5.0 °C.

Press Δ or ∇ to change setting value, then press “M” save and enter interface for temp. Range setting (0~99°C):

1. “-HI-” displays, the default value is 35°C. Press Δ or ∇ can set the value;
2. Press “M” again, “-LO-” displays, the default value is 5°C. Press Δ or ∇ can set the value;
3. Then press “M” to confirm and return to “OFF”.

● **Screen Brightness/ Fan continuously work/ Key-touch volume**

Under the shutdown state, press & hold “M” will enter interface for screen brightness selection (LED), Press Δ or ∇ can choose: (press “M” to confirm the choice and enter into next setting)

111 indicates the screen will always be full bright when power on;

000 (default) indicates without button operation for a long time (15 seconds), the screen will be half bright automatically.

Press “M” again will enter interface for Fan continuously work choice:

000 (default) indicates device will shutdown fan and valve if room temp. Reaches setting temp.;

001 indicates device will shutdown valve only if room temp. Reaches setting temp. The fan will continuously work in low speed.

Press “M” again will enter interface for Key-touch volume (BEEP) setting:

0 : Off 1: Low(default) 2: High

- **Temp. Sensor Error**

If temperature sensor does not work, “E1” displays , fan stops and valve closes automatically.

Z-Wave Operation

- **Including & Excluding of Z-Wave network**

Under the shutdown state, press & hold ∇ to enter interface for inclusion or exclusion of Z-Wave network. Before device included into network, “- - -” will display on the screen. Then press ∇ once, device will enter learning mode to get a node ID. If inclusion is success, a node ID will display on the screen in a few seconds.

A node ID can always inform us whether the device is in the network or not.

Note: Follow the same steps to exclude the device from the network.

After inclusion, turn off the device and then turn it on. Now the device is ready to be operated by controller/ gateway in Z-Wave network.

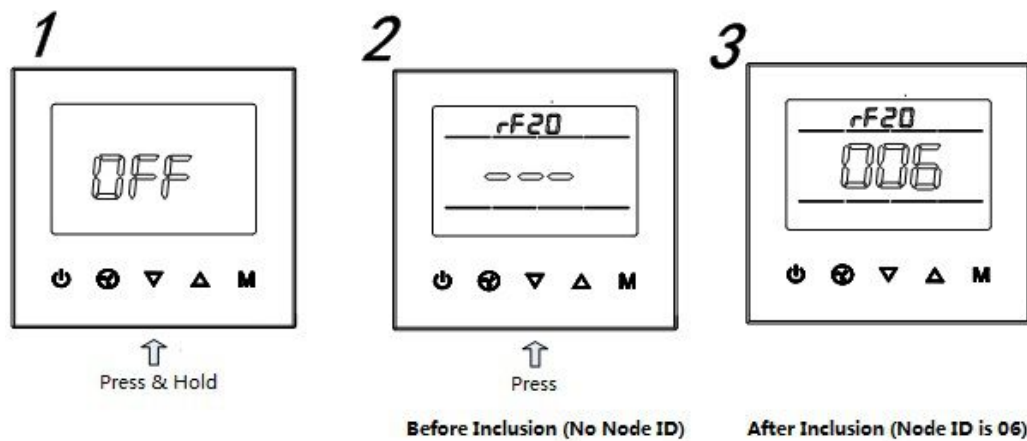

- **Association Group**

Thermostat supports 1 association group. A gateway is suggested to associate with this group. Then if any changes happen, such as: temperature, working mode, fan state etc., the thermostat will report to this associated device (gateway). When the detected temperature change $\geq 0.5^{\circ}\text{C}$, device will send unsolicited report to the gateway.

- **Command Class supported by the device:**

COMMAND_CLASS_BASIC;
 COMMAND_CLASS_THERMOSTAT_SETPOINT;
 COMMAND_CLASS_THERMOSTAT_MODE;
 COMMAND_CLASS_THERMOSTAT_FAN_MODE;
 COMMAND_CLASS_THERMOSTAT_OPERATING_STATE;
 COMMAND_CLASS_SENSOR_MULTILEVEL;
 COMMAND_CLASS_ASSOCIATION;
 COMMAND_CLASS_VERSION;
 COMMAND_CLASS_MANUFACTURER_SPECIFIC

1-year Limited Warranty

MCOHome warrants this product to be free from defects in material and workmanship under normal and proper use for one year from purchase date of the original purchaser. MCOHome will, at its option, either repair or replace any part of its products that prove defective by reason of improper workmanship or materials. THIS LIMITED WARRANTY DOES NOT COVER ANY DAMAGE TO THIS PRODUCT THAT RESULTS FROM IMPROPER INSTALLATION, ACCIDENT, ABUSE, MISUSE, NATURAL DISASTER, INSUFFICIENT OR EXCESSIVE ELECTRICAL SUPPLY, ABNORMAL MECHANICAL OR ENVIRONMENTAL CONDITIONS, OR ANY UNAUTHORIZED DISASSEMBLY, REPAIR OR MODIFICATION. This limited warranty shall not apply if: (i) the product was not used in accordance with any accompanying instructions, or (ii) the product was not used for its intended function. This limited warranty also does not apply to any product on which the original identification information has been altered, obliterated or removed, that has not been handled or packaged correctly, that has been sold as second-hand or that has been resold contrary to Country and other applicable export regulations.