

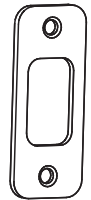

Yale *real* Living

Yale Real Living® Key Free Touchscreen Deadbolt T1L with **WAVE**® Installation and Programming Instructions

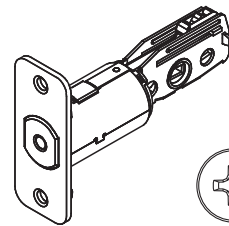
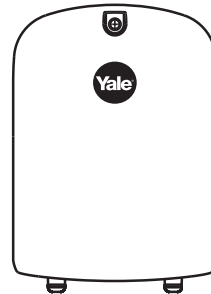
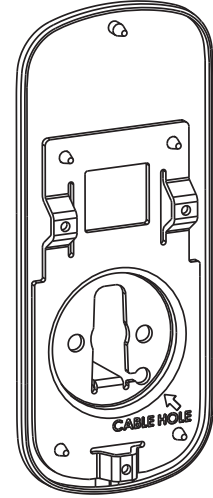
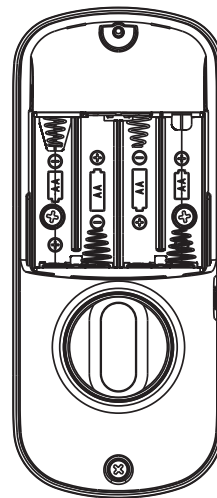
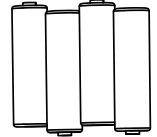
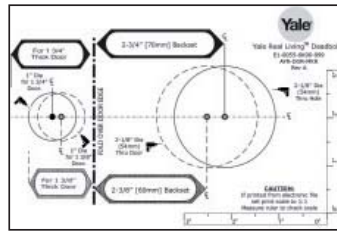
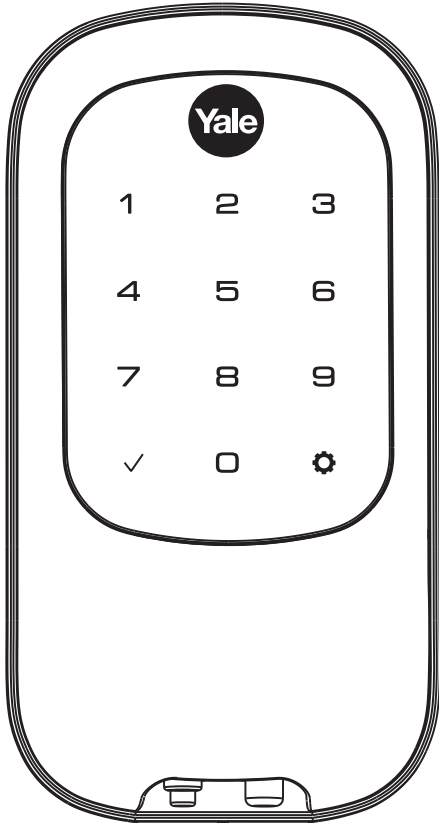

x4
#7 wood & #8-32
machine x 20mm
Combination screws



x3
#8-32 x 5/16"
Machine screws



x2
M6x47mm
Long through bolt

Before you begin

**DOWNLOAD
THE BILT APP**

for 3D interactive
instructions & to register
your product



BILT.



FAILURE TO FOLLOW THESE INSTRUCTIONS COULD RESULT IN DAMAGE TO THE PRODUCT AND VOID THE FACTORY WARRANTY

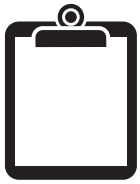

Preparing Door

Yale
Yale Real Living® Deadbolt
E1-6051-0010-000
A/B-0000000
Rev. 0

For 1 3/4" Thick Door: 2-3/4" (70mm) Backset, 1" Dia. for 2-3/4" Dia. Hole, 1" Dia. for 2" Dia. Hole

For 2 3/8" Thick Door: 2-3/8" (68mm) Backset, 2-1/8" Dia. (54mm) Hole Dia., 2-1/8" Dia. (54mm) Hole Dia.

CAUTION: If protected from electronic, the lock will not work. See 2-3. Measure door to check code.

1

Installing Latch & Strike Plate



x4

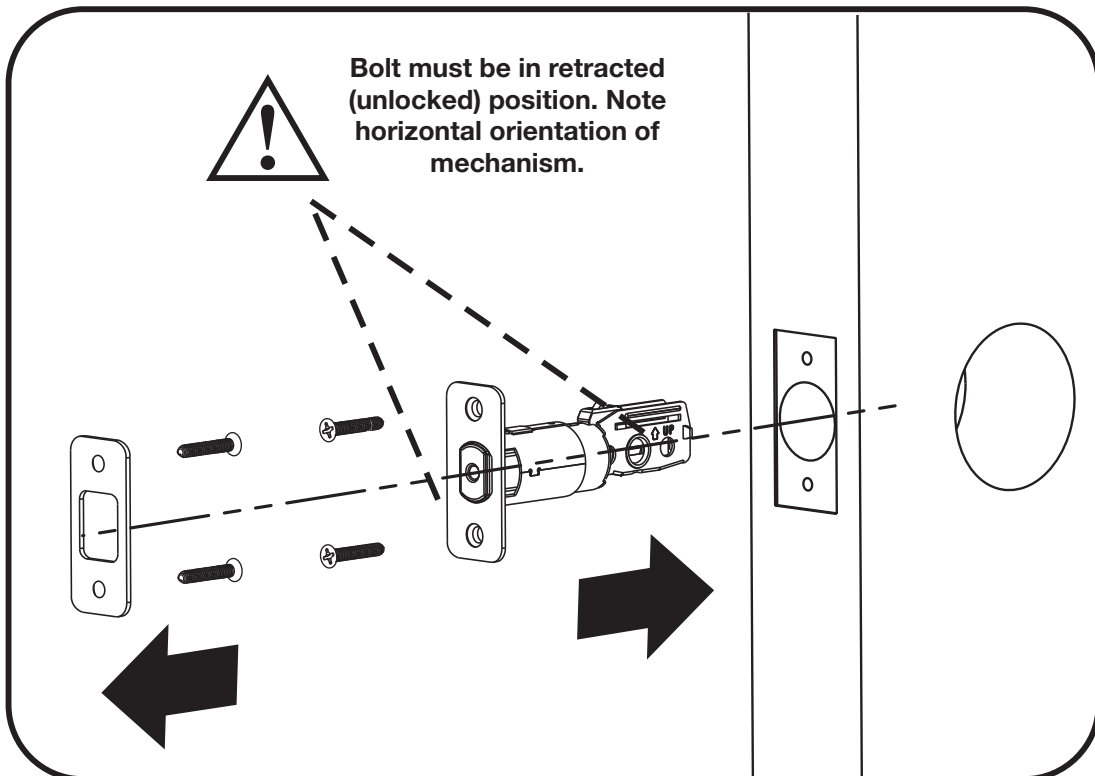
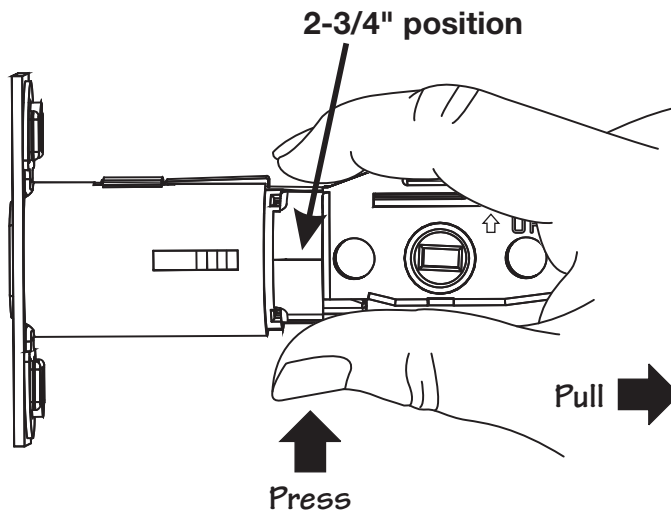
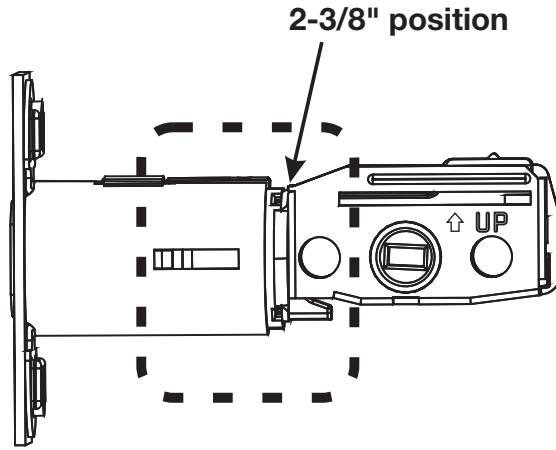

2

Installing Touchscreen Escutcheon



Inside of Door

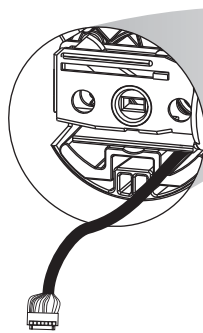

Outside of Door

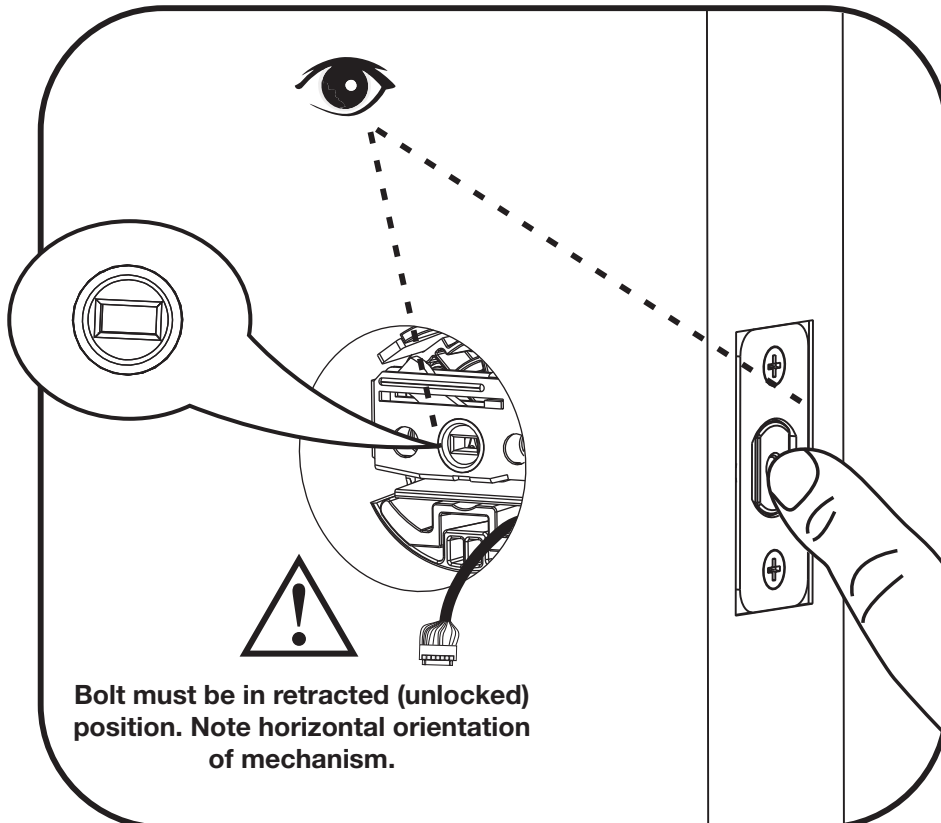
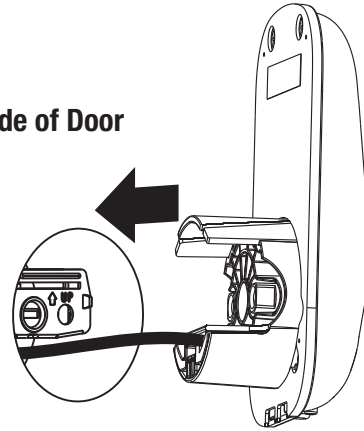

Bolt must be in retracted (unlocked) position. Note horizontal orientation of mechanism.

3

Installing Interior Mounting Plate

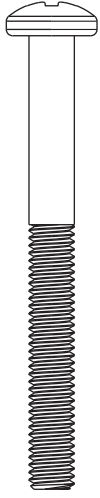

x2

Loosen screw to
remove cover.

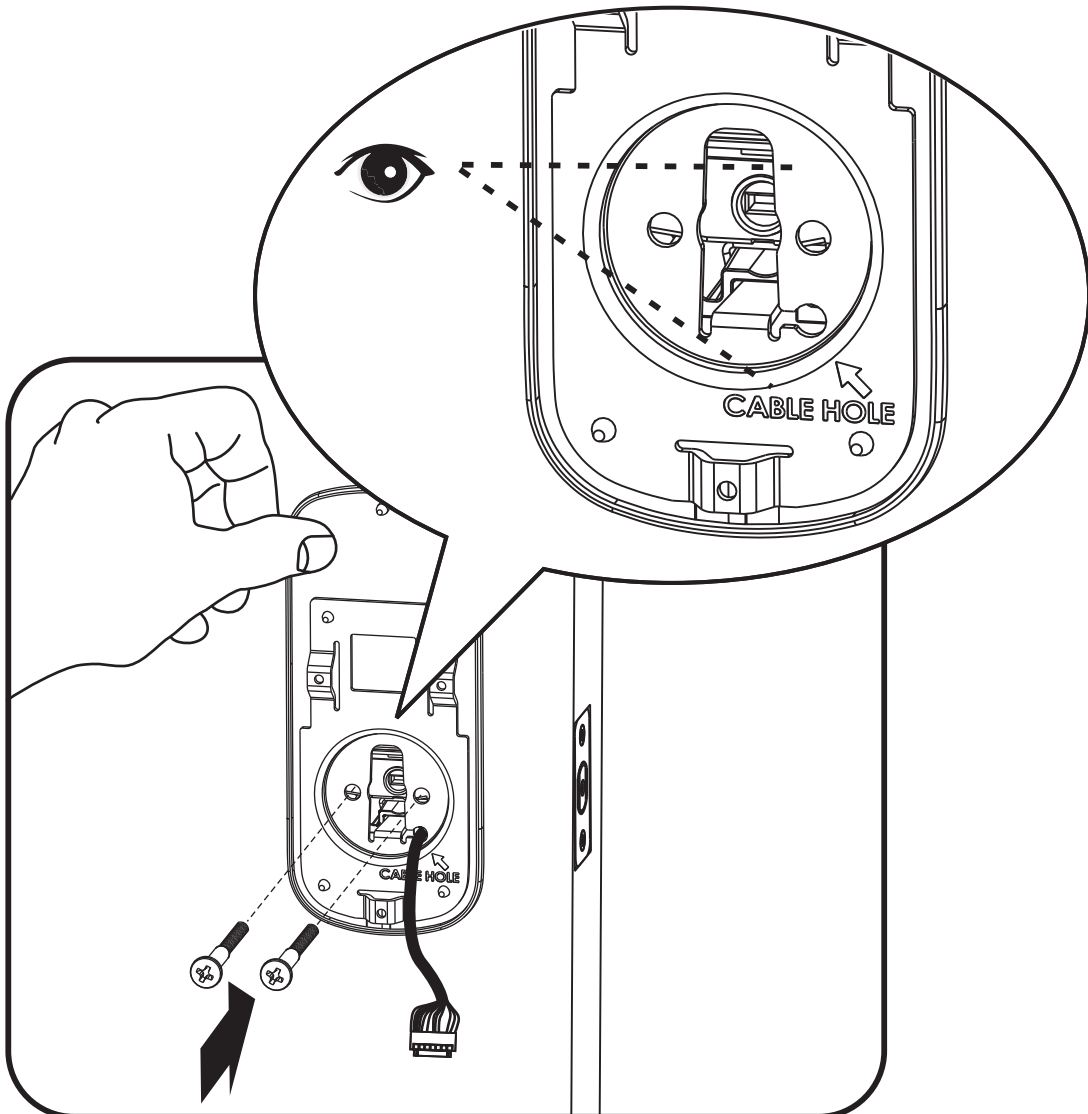
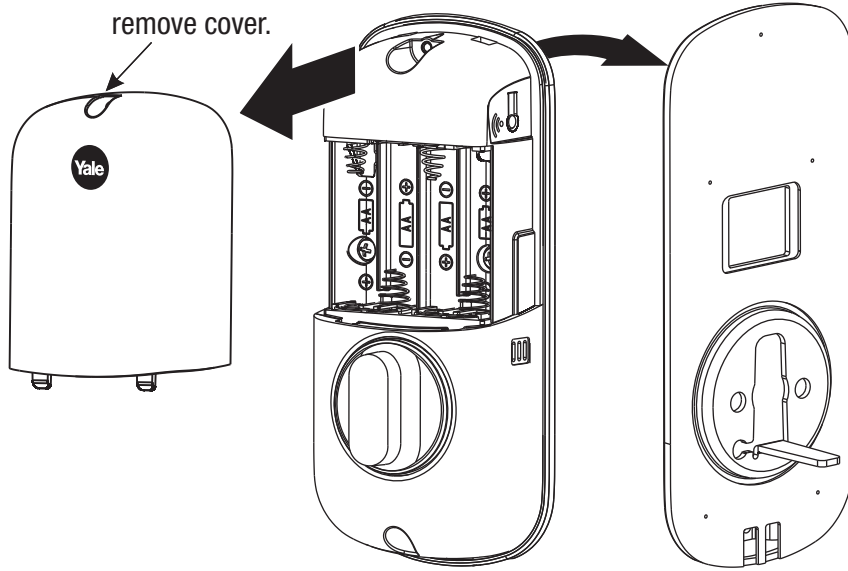

4

Attaching the Cable Assembly

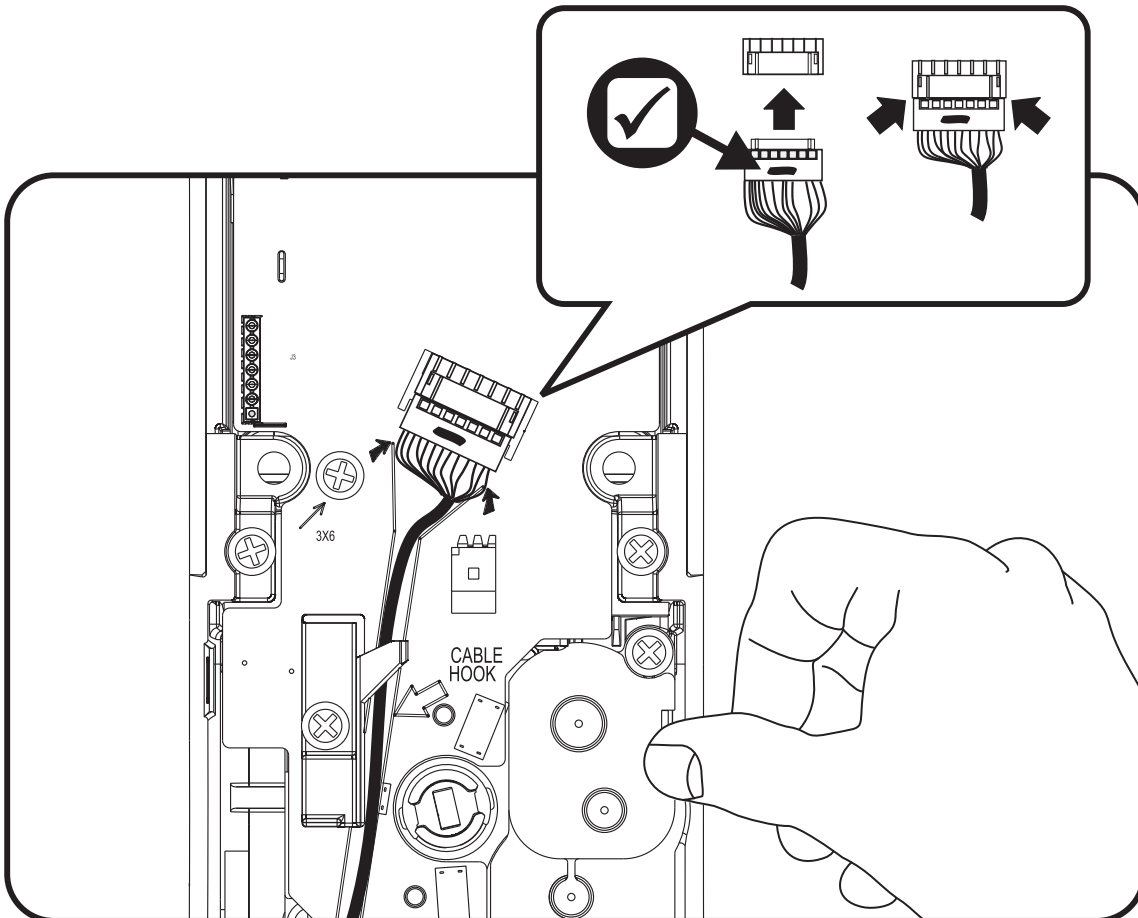
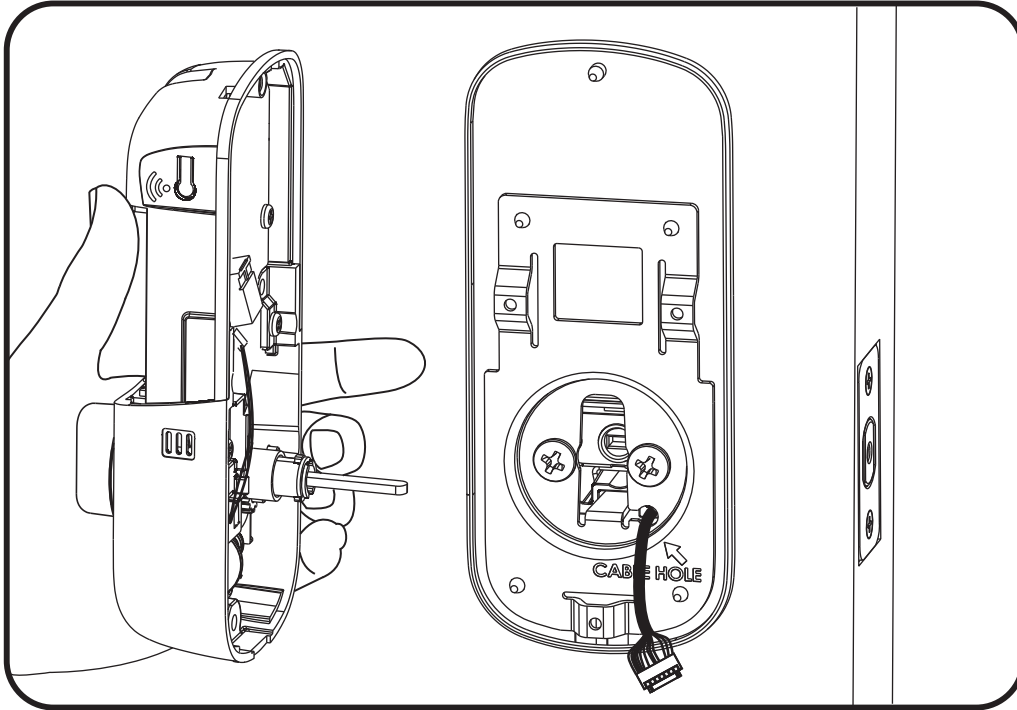

5

Installing Interior Escutcheon



x3

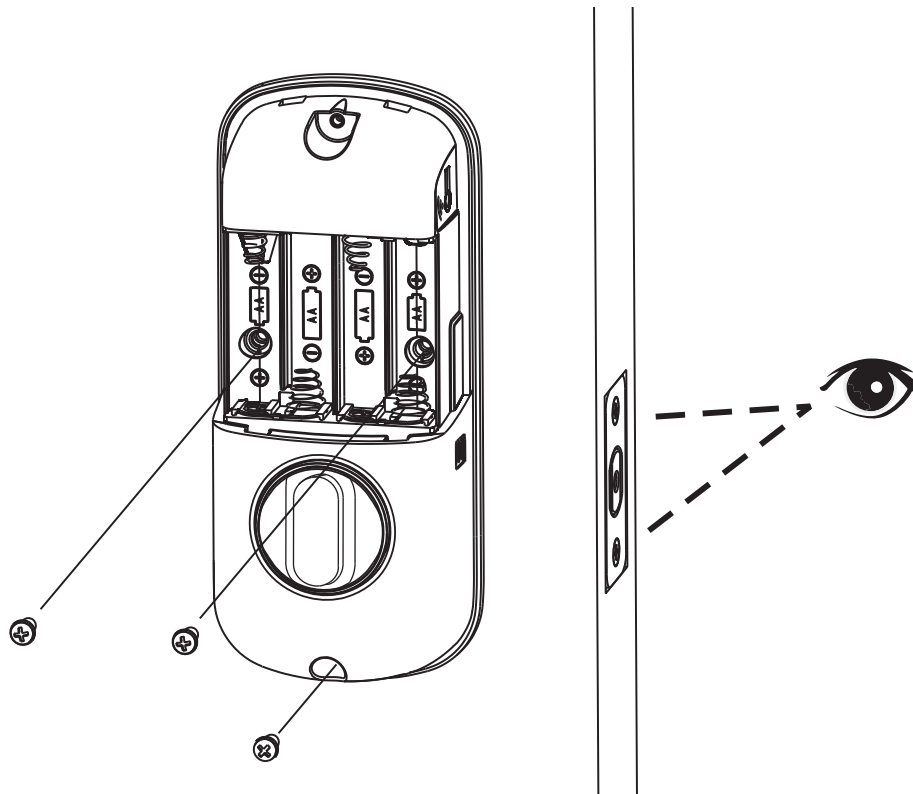
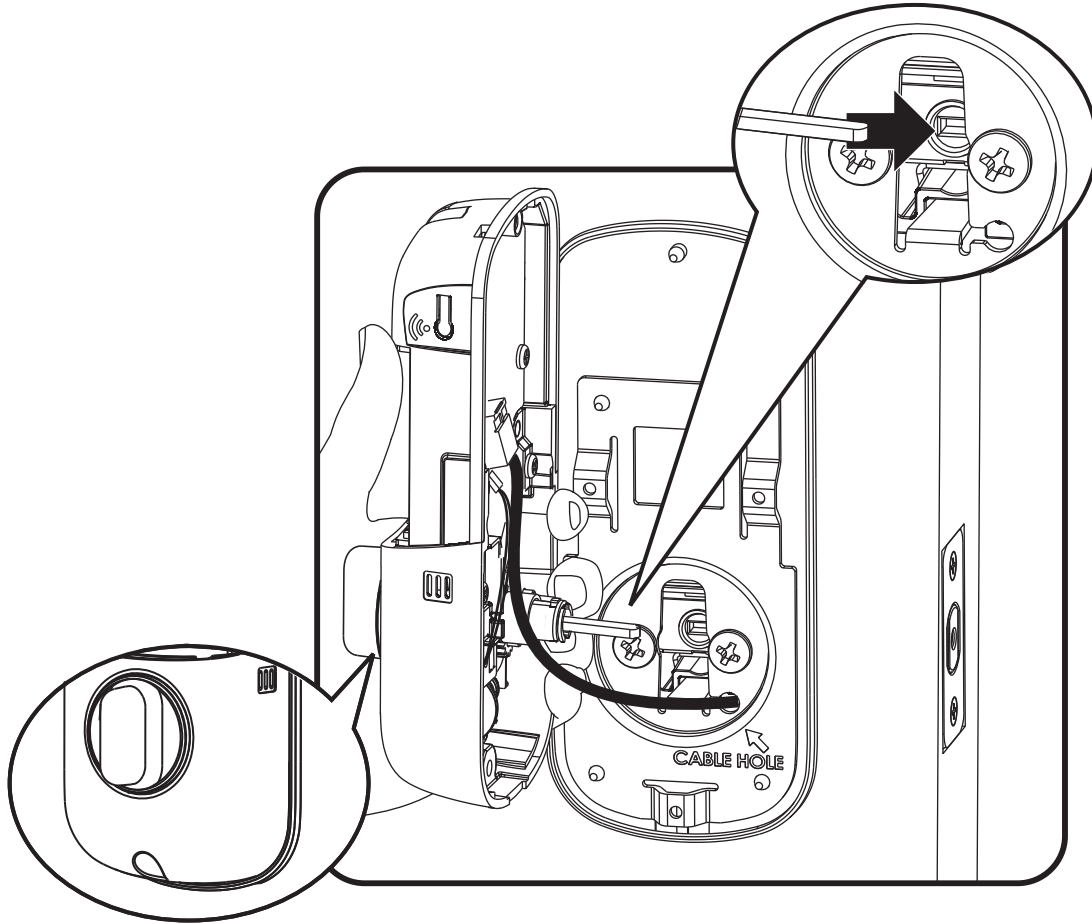



Testing Operation

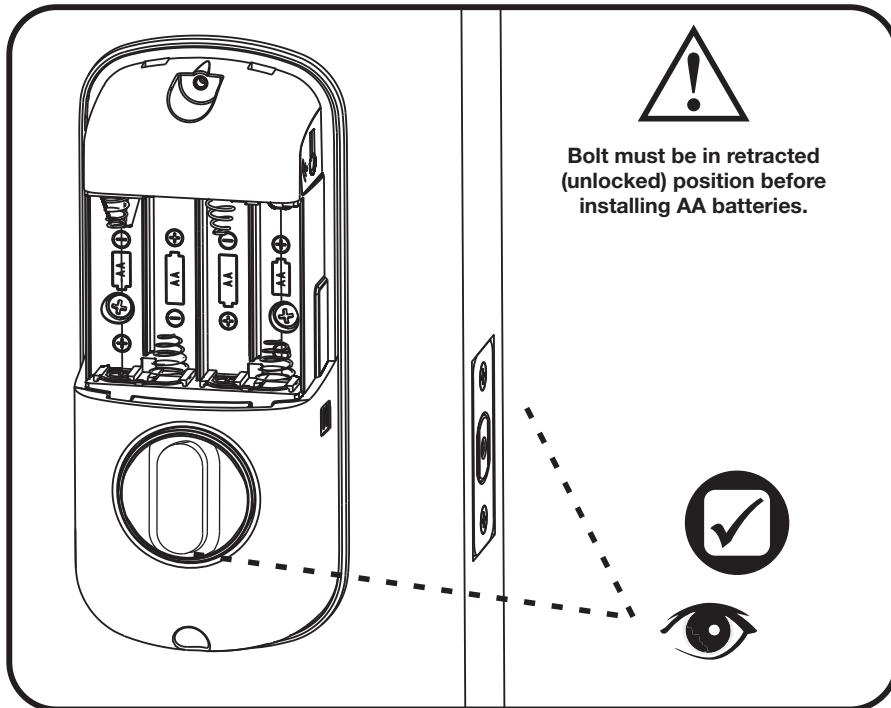
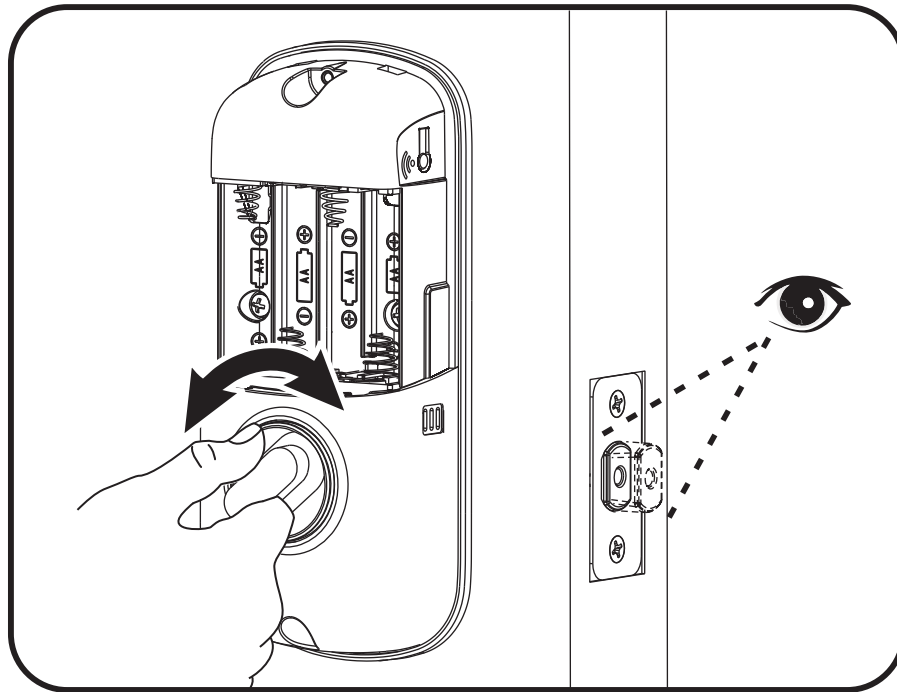



Handing the Lock

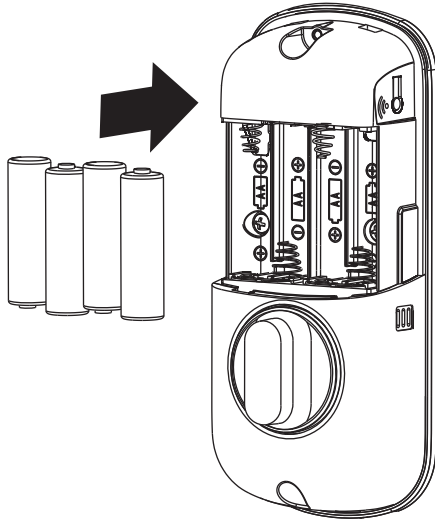

Press .
Enter new Master PIN code (4-8
digits). Press  to complete.



After entering the Master PIN
code, press any key to complete
handing.

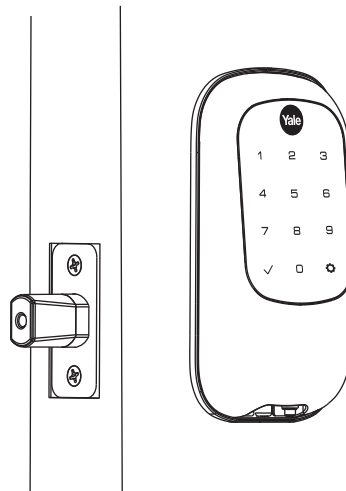

6

Installing Cover

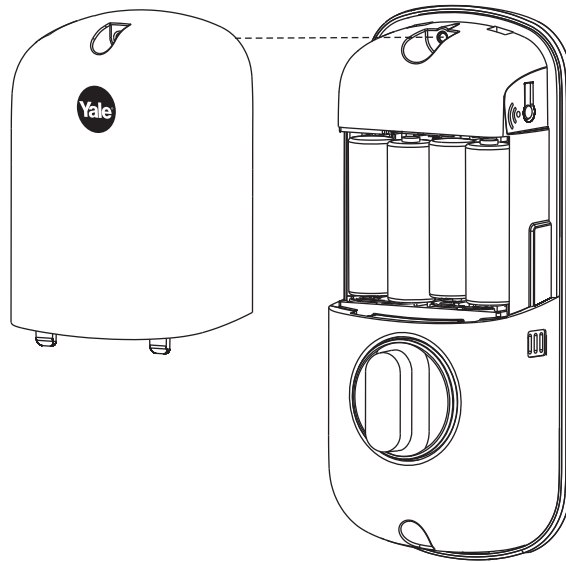

Congratulations, you've installed the Yale Real Living® Key Free Touchscreen Deadbolt T1L with **ZWAVE®**! Turn sheet over for Programming Instructions to customize your product.

Programming Instructions

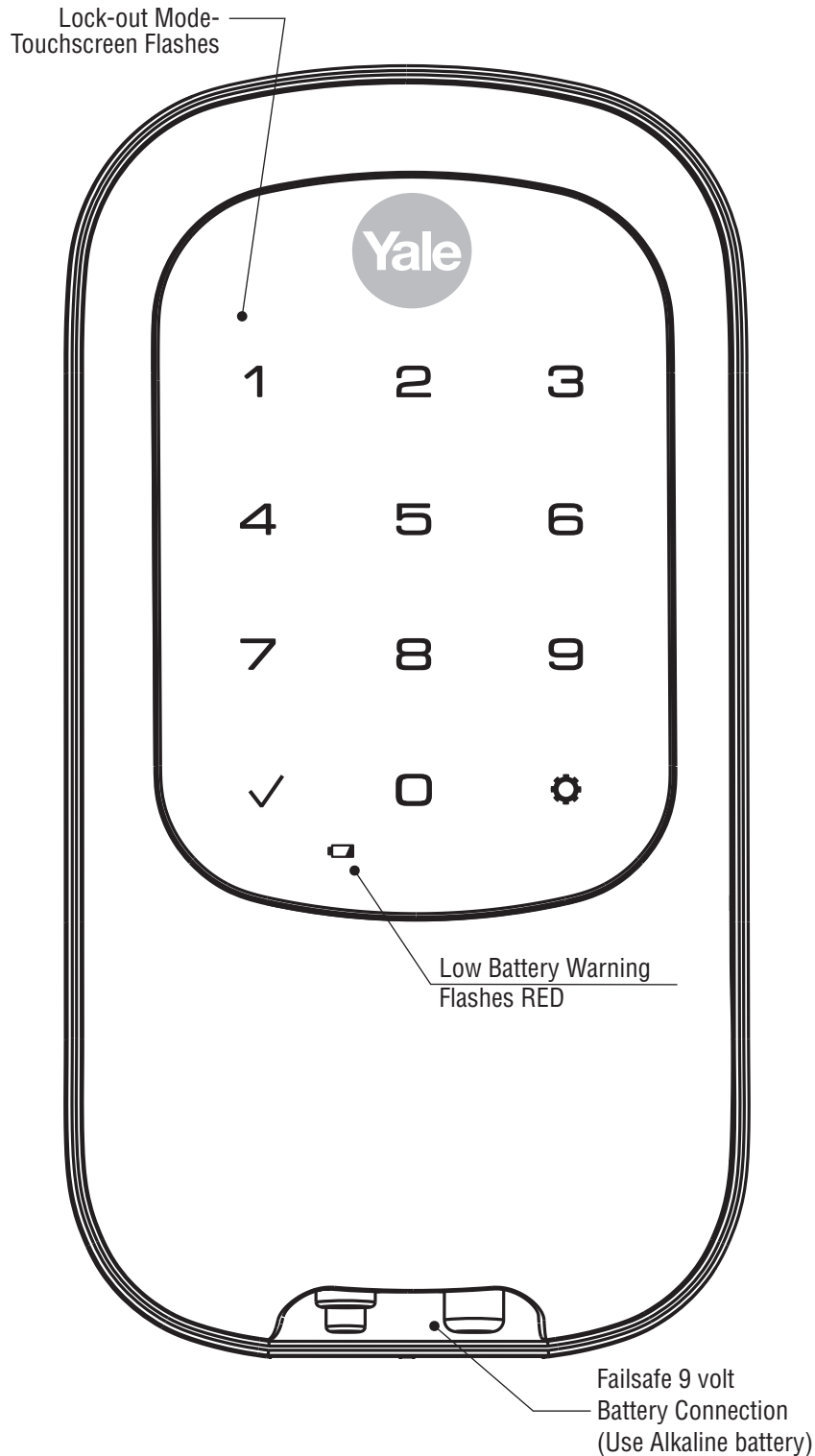

Master PIN Code must be created before any further programming.
Max User Codes = 100

Warning: Changes or modifications to this device, not expressly approved by Yale Security Inc. could void the user's authority to operate the equipment.

1

Creating Master PIN Code

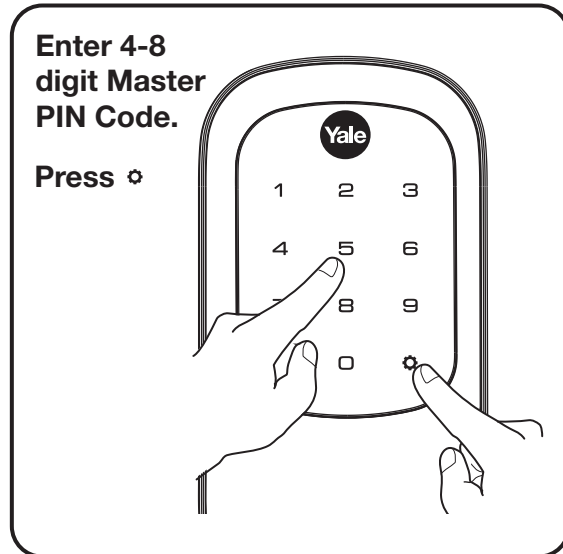
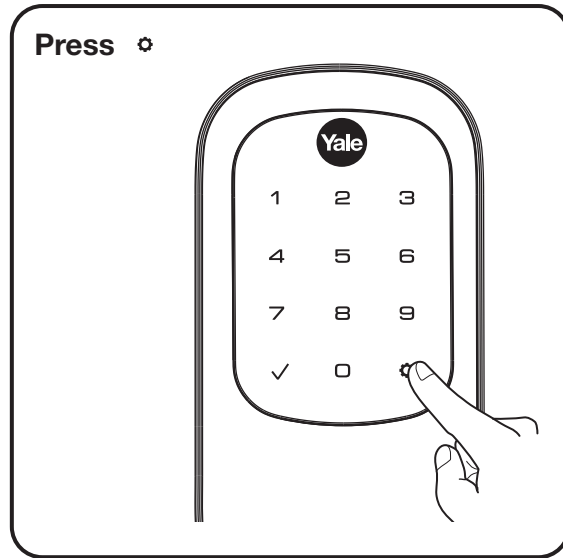

2

Creating User PIN Codes

Master PIN code must be created first.

*Max User Codes = 100

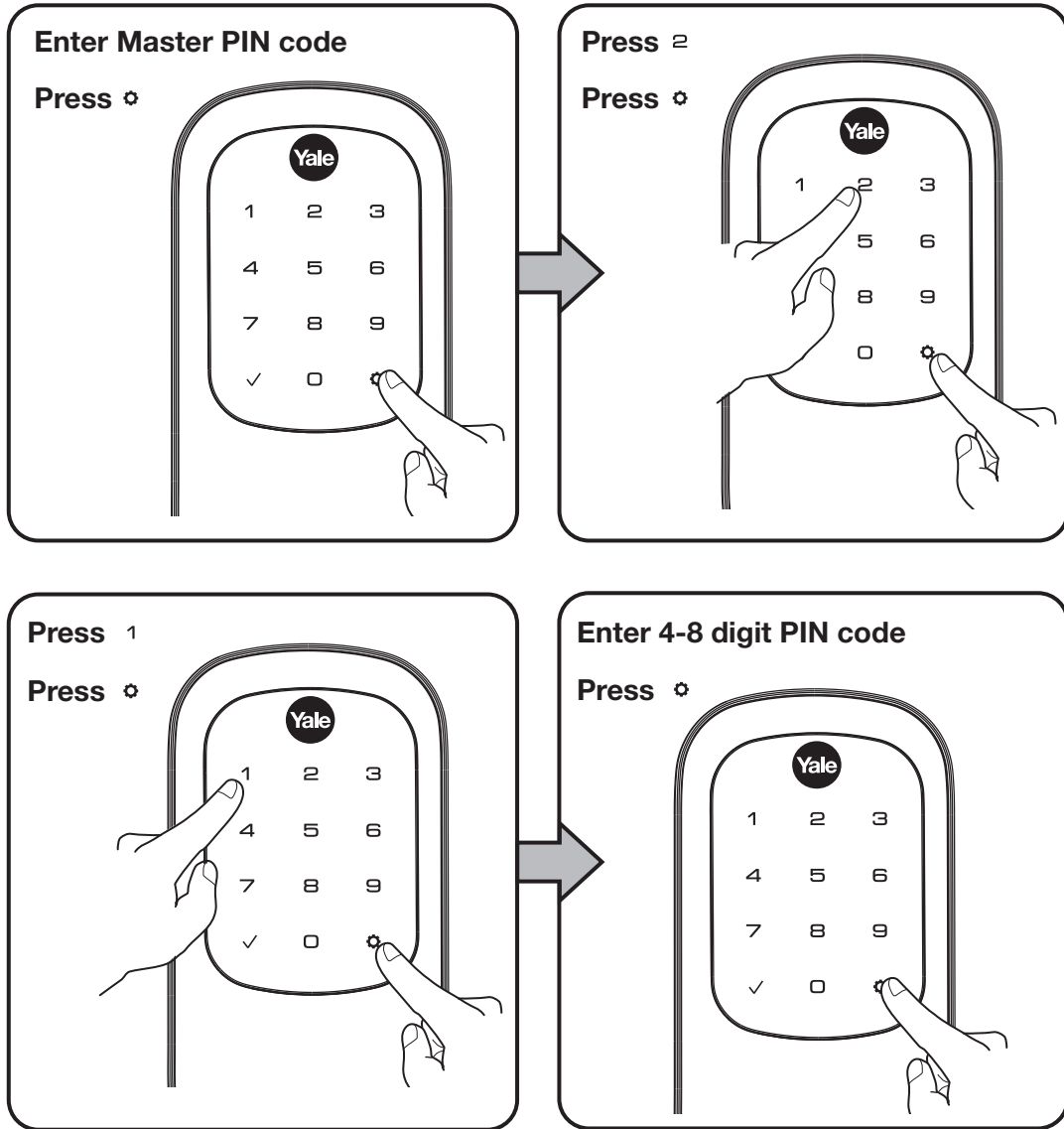

Resetting Lock to Factory Default

When lock is reset to factory defaults all user codes (including the Master PIN code*) are deleted and all programming features are reset to original default settings (see "Factory Default Settings").

1. Remove the battery cover.
2. Remove the batteries.
3. While pressing the reset button (minimum of 3 seconds) reinstall batteries. Release reset button.
4. Replace battery cover.

Upon reset, Master Code creation is the only option available and must be performed prior to any other programming of the lock.

NOTE: After setting the Master Code, press any key to complete handing of the lock.

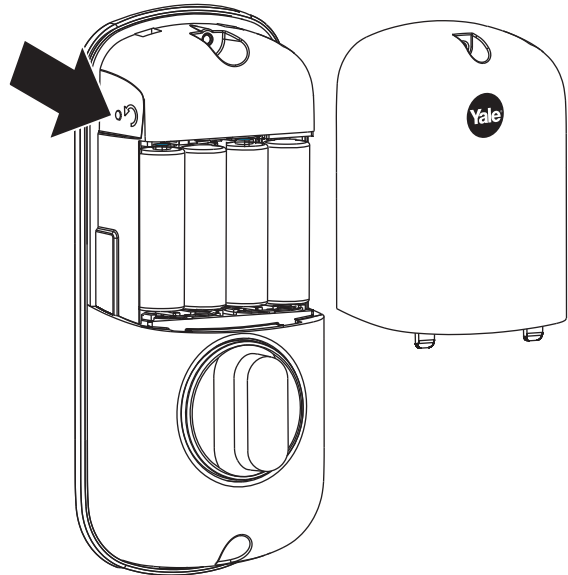



Enrolling Lock In Z-WAVE® Network

Your network controller first needs to be in enrollment or exclusion mode for the lock to be enrolled or removed from network.

Once you put the controller in the enrollment or exclusion mode, the lock can be enrolled or removed in the Z-Wave® network two ways - through the touchscreen using the #7 key (see Programming Through Menu Mode) or by pressing the  button.

To enroll lock using the  button option:

1. Remove the battery cover.
2. Press  button and hold until unit beeps two (2) times.
3. Release button and network joining automatically begins.
4. Replace battery cover.

To remove lock using the  button option:

1. Remove the battery cover.
2. Press  button and hold until unit beeps five (5) times.
3. Release button and network removal automatically begins.
4. Replace battery cover.

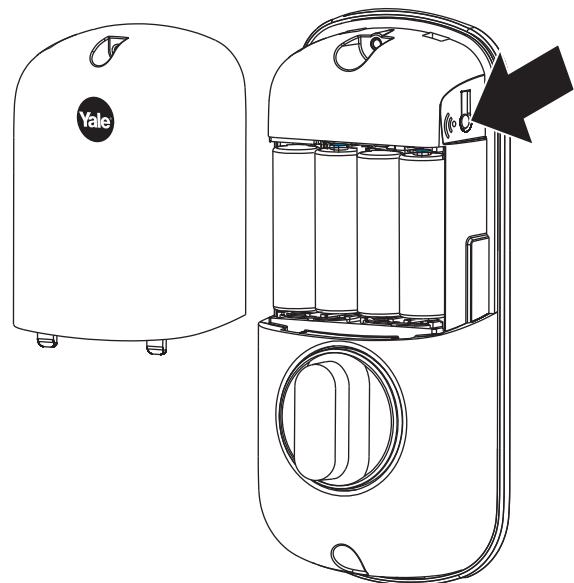

Definitions

All Code Lockout Mode: This feature is enabled by the Master code. When enabled, it restricts all user (except Master) PIN code access. When attempting to enter a code while the unit is in Lockout, the touchscreen flashes 8 times and the lock beeps 3 times as well.

Audio Mode: Choosing **Disable (3)** in Audio mode shuts off the code confirmation tone play-back for use in quiet areas. Audio mode is enabled or disabled through feature programming by the Master code.

Automatic Re-lock Time: After a successful unlock, the unit will automatically re-lock after thirty (30) seconds.

Low Battery: When battery power is low, the Low Battery Warning Indicator flashes RED. If battery power is completely lost, use the 9Volt battery override. To use the 9V battery override apply 9V battery, in either direction, to terminals below the touchscreen for backup power option. Wake up the lock and enter your pin code to unlock the door.

Master PIN Code: The Master PIN code is used for programming and for feature settings. **It must be created prior to programming the lock.** The Master code will also operate (unlock/lock) the lock.

Network Setting: This setting is available thru the main Menu (7) and allows the lock to connect with a network controller. It is also available through the wireless button on the interior escutcheon .

One Touch Locking: When the latch is retracted, activating the touchscreen will extend the latch (during Automatic Re-lock duration or when Automatic Re-lock is disabled).

Shutdown Time: The unit will shutdown (flashing touchscreen) for sixty (60) seconds and not allow operation after the wrong code entry limit has been met.

Tamper Alert: Audible alarm sounds if attempting to forcibly remove outside lock from door.

User PIN Code: The User code operates the lock. Maximum number of user codes is 100.

Wrong Code Entry Limit: After five (5) unsuccessful attempts at entering a valid PIN code, the unit will shut down and not allow operation.

Feature Programming Through Menu Mode Using Master PIN code*

1. Enter the 4-8 digit Master PIN code followed by the ***** key.
2. Enter digit corresponding to the function to be performed followed by the ***** key.

*The Master PIN code must be registered prior to any other programming of the lock.

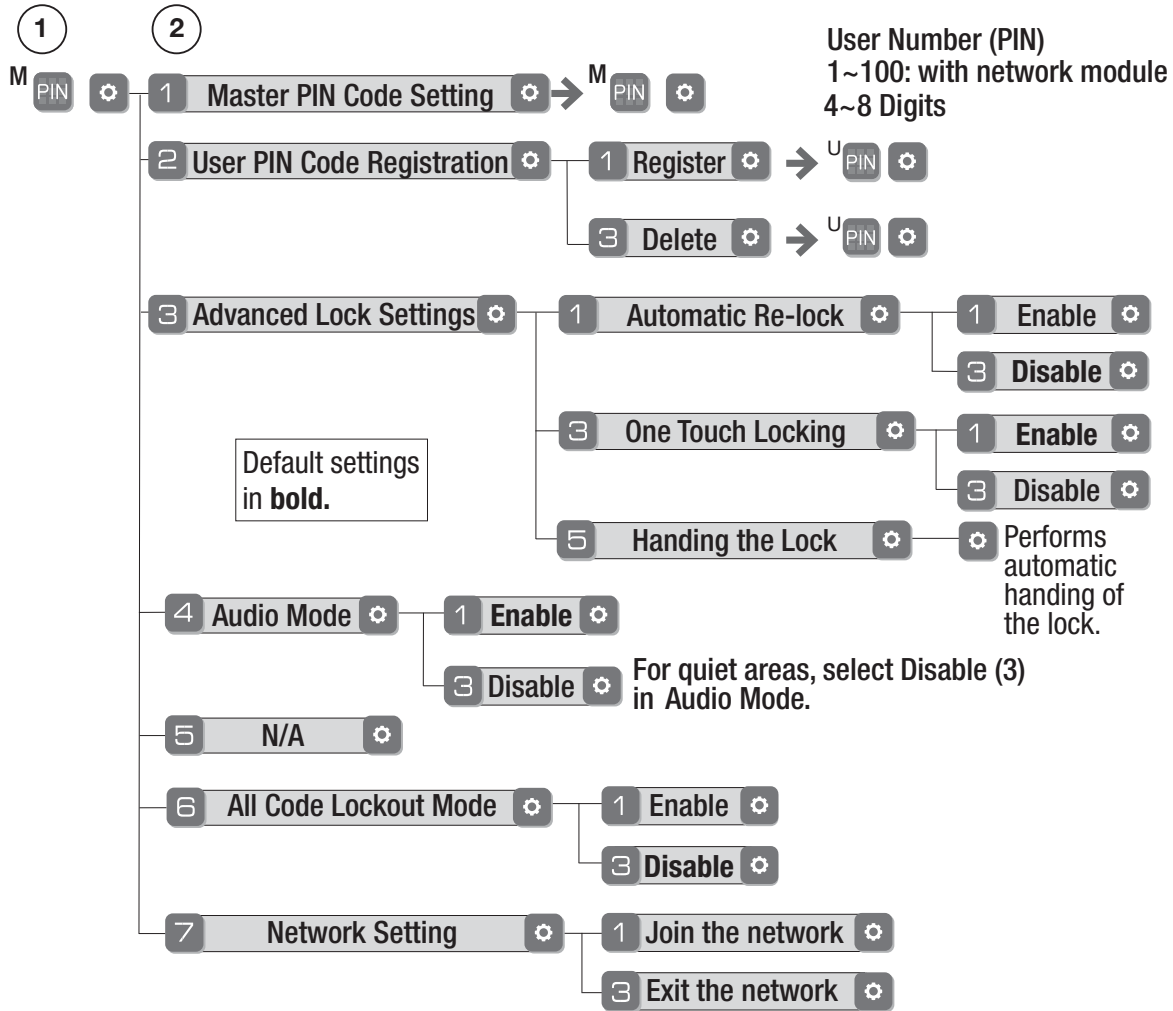

Factory Settings

Settings	Factory Setting
Master PIN Code	Registration <i>required</i> *
Automatic Re-lock	Disabled
One Touch Locking	Enabled
Audio	Enabled
Automatic Re-lock Time	30 Seconds
Wrong Code Entry Limit	5 Times
Shutdown Time	60 Seconds

*The Master PIN code must be registered prior to any other programming of the lock.

Programming Troubleshooting

Symptom	Suggested Action
Lock does not respond – door is open and accessible.	<ul style="list-style-type: none"> • Press each touchscreen key for response when pressed. • Check batteries are installed and oriented correctly (polarity) in the battery case. • Check batteries are in good condition; replace batteries* if discharged. • Check to see if cable is fully connected and not pinched.
Lock does not respond – door is locked and inaccessible.	<ul style="list-style-type: none"> • Batteries may be completely discharged. • Apply 9V battery to terminals below the touchscreen for backup power option.
Unit chimes to indicate code acceptance, but the door will not open.	<ul style="list-style-type: none"> • Check to see if there is another locking device on the door. • Check the door gaps for any foreign objects between door and frame. • Check that the cable is firmly connected to the PC board.
Unit operates to allow access, but will not automatically re-lock.	<ul style="list-style-type: none"> • Check to see if Auto Re-lock Mode is enabled. • If low battery indicator is lit (see below), change batteries*.
PIN codes will not register.	<ul style="list-style-type: none"> • PIN codes must consist of 4 to 8 digits to register. • The same PIN code cannot be used for multiple users. • Registration/management of PIN codes is set by the authority of the Master Code. • Contact the Master user. • User codes must be entered within 20 seconds or the process will have to be restarted. • Check mark ✓ or gear ⚙ cannot be used as part of the PIN code.
Upon entering a PIN code and pressing the ✓ key, the lock gives a series of beeps, flashes red 7 times, and does not unlock.	<ul style="list-style-type: none"> • All Code Lockout Mode is enabled. • Only the Master can enable/disable All Code Lockout Mode. • Contact the Master user.
Upon entering a PIN code and pressing the ✓ key, there are different tones.	<ul style="list-style-type: none"> • Check to see if the lock is set to All Code Lockout Mode. • Setting/managing All Code Lockout Mode is done through Master Code only. Contact the Master user.
The unit operates, but it makes no sound.	<ul style="list-style-type: none"> • Enable Audio Mode.
The unit displays intermittent RED flashes.	<ul style="list-style-type: none"> • This is the Low Battery indicator alerting that it is time to replace the batteries. Replace all four (4) batteries* with new AA Alkaline batteries.
Upon entering a PIN code and pressing the ✓ key, the unit responds with a series of beeps and the touchscreen flashes three times.	<ul style="list-style-type: none"> • The digits entered were incorrect or incomplete. Re-enter the correct code followed by the check mark ✓ key.

* When batteries are replaced, Network locks have a real time clock that will be set through the User Interface (UI); it is recommended to verify correct date and time particularly those locks operating under Daylight Saving Time (DST).

FCC:

FCC ID: U4A-YRIZW1US (Z-Wave®)

Model(s): YRD120-ZW-US

This equipment has been tested and found to comply with the limits for a Class B digital device, pursuant to Part 15 of the FCC Rules. These limits are designed to provide reasonable protection against harmful interference in a residential installation. This equipment generates, uses, and can radiate radio frequency energy and, if not installed and used in accordance with the instructions, may cause harmful interference to radio communications. However, there is no guarantee that interference will not occur in a particular installation. If this equipment does cause harmful interference to radio or television reception, which can be determined by turning the equipment off and on, the user is encouraged to try to correct the interference by one or more of the following measures:

- Reorient or relocate the receiving antenna.
- Increase the separation between the equipment and receiver.
- Connect the equipment into an outlet on a circuit different from that to which the receiver is connected.
- Consult the dealer or an experienced radio/TV technician for help.

Industry Canada:

Canadian ID: 6982A-YRIZW1US (Z-Wave®)

Model(s): YRD120-ZW-US

This Class B digital apparatus meets all requirements of the Canadian Interference Causing Equipment Regulations. Operation is subject to the following two conditions: (1) this device may not cause harmful interference, and (2) this device must accept any interference received, including interference that may cause undesired operation.

Cet appareillage numérique de la classe B répond à toutes les exigences de l'interférence canadienne causant des règlements d'équipement. L'opération est sujette aux deux conditions suivantes: (1) ce dispositif peut ne pas causer l'interférence nocive, et (2) ce dispositif doit accepter n'importe quelle interférence reçue, y compris l'interférence qui peut causer l'opération peu désirée.

Section 7.1.2 of RSS-GEN Under Industry Canada regulations, this radio transmitter may only operate using an antenna of a type and maximum (or lesser) gain approved for the transmitter by Industry Canada. To reduce potential radio interference to other users, the antenna type and its gain should be so chosen that the equivalent isotropically radiated power (e.i.r.p.) is not more than that necessary for successful communication.

En vertu des règlements d'Industrie Canada, cet émetteur radio ne peut fonctionner avec une antenne d'un type et un maximum (ou moins) approuvés pour gagner de l'émetteur par Industrie Canada. Pour réduire le risque d'interférence aux autres utilisateurs, le type d'antenne et son gain doivent être choisies de façon que la puissance isotrope rayonnée équivalente (PIRE) ne dépasse pas ce qui est nécessaire pour une communication réussie.

Section 7.1.3 of RSS-GEN This Device complies with Industry Canada License-exempt RSS standard(s). Operation is subject to the following two conditions: 1) this device may not cause interference, and 2) this device must accept any interference, including interference that may cause undesired operation of the device.

Cet appareil est conforme avec Industrie Canada RSS standard exemptes de licence(s). Son fonctionnement est soumis aux deux conditions suivantes: 1) ce dispositif ne peut causer des interférences, et 2) cet appareil doit accepter toute interférence, y compris les interférences qui peuvent causer un mauvais fonctionnement du dispositif.

NOTE TO INSTALLER AND CONSUMER

While Yale® has included several features to prevent lockout (9-Volt battery jumper, low battery warnings), it is still possible for a lockout situation to occur. Because this product does not have a mechanical override (a key), Yale® recommends to use this product in an environment where there are additional entry points into the dwelling.

Yale Locks & Hardware

Product Support Tel 800.810.WIRE (9473) • www.yalelocks.com

Yale Locks & Hardware is a division of Yale Security Inc., an ASSA ABLOY Group company.

Yale® and Yale Real Living® are registered trademarks of Yale Security Inc., an ASSA ABLOY Group company.

Copyright © 2017, Yale Security Inc., an ASSA ABLOY Group company.

All rights reserved. Reproduction in whole or in part without the express written permission of Yale Security Inc. is prohibited.

YALE, with its unique global reach and range of products, is the world's favorite lock
–the preferred solution for securing your home, family and personal belongings.

ASSA ABLOY is the global leader in door opening solutions,
dedicated to satisfying end-user needs for security, safety and convenience.